

# Panasonic<sup>®</sup>

## Operating Instructions

### Progressive Wide Plasma Display

---

Model No. **TH-37PWD6**  
**TH-42PWD6**

### High Definition Plasma Display

---

Model No. **TH-42PHD6**  
**TH-50PHD6**



Before connecting, operating or adjusting this product, please read these instructions completely. Please keep this manual for future reference.

**English**

	<b>WARNING</b> <b>RISK OF ELECTRIC SHOCK</b> <b>DO NOT OPEN</b>	
<b>WARNING: To reduce the risk of electric shock, do not remove cover or back. No user-serviceable parts inside. Refer servicing to qualified service personnel.</b>		



The lightning flash with arrow-head within a triangle is intended to tell the user that parts inside the product are a risk of electric shock to persons.



The exclamation point within a triangle is intended to tell the user that important operating and servicing instructions are in the papers with the appliance.

**WARNING: To prevent damage which may result in fire or shock hazard, do not expose this apparatus to rain or moisture. Do not place containers with water (flower vase, cups, cosmetics, etc.) above the set. (including on shelves above, etc.)**

**WARNING:** 1) To prevent electric shock, do not remove cover. No user serviceable parts inside. Refer servicing to qualified service personnel.  
2) Do not remove the grounding pin on the power plug. This apparatus is equipped with a three pin grounding-type power plug. This plug will only fit a grounding-type power outlet. This is a safety feature. If you are unable to insert the plug into the outlet, contact an electrician.  
Do not defeat the purpose of the grounding plug.



# Important Safety Instructions

- 1) Read these instructions.  
All the safety and operating instructions should be read before the appliance is operated.
- 2) Keep these instructions.  
The safety and operating instructions should be retained for future reference.
- 3) Heed all warnings.  
All warnings on the appliance and in the operating instructions should be adhered to.
- 4) Follow all instructions.  
All operating and use instructions should be followed.
- 5) Do not use this apparatus near water.  
For example, near a bathtub, wash bowl, kitchen sink, or laundry tub, in a wet basement, or near a swimming pool, and the like.
- 6) Clean only with dry cloth.  
Do not use liquid cleaners or aerosol cleaners. Use a dry cloth for cleaning.
- 7) Do not block any ventilation openings. Install in accordance with the manufacturer's instructions.  
Slots and Openings in the cabinet are provided for ventilation and to ensure reliable operation of the product and to protect it from overheating. The openings should never be blocked by placing the product on a bed, sofa, rug, or other similar surface.
- 8) Do not install near any heat sources such as radiators, heat registers, stoves, or other apparatus (including amplifiers) that produce heat.  
This product should not be placed in a built-in installation such as a bookcase or rack unless proper ventilation is provided or the manufacturer's instructions have been adhered to.
- 9) Do not defeat the safety purpose of the polarized or grounding-type plug. A polarized plug has two blades with one wider than the other. A grounding type plug has two blades and a third grounding prong. The wide blade or the third prong are provided for your safety. If the provided plug does not fit into your outlet, consult an electrician for replacement of the obsolete outlet.
- 10) Protect the power cord from being walked on or pinched particularly at plugs, convenience receptacles, and the point where they exit from the apparatus.
- 11) Only use attachments / accessories specified by the Manufacturer.
- 12) Use only with the cart, stand, tripod, bracket, or table specified by the manufacturer, or sold with the apparatus. When a cart is used, use caution when moving the cart / apparatus combination to avoid injury from tip-over.  
Quick stops, excessive force, and uneven surfaces may cause the appliance and cart combination to overturn.
- 13) Unplug this apparatus during lightning storms or when unused for long periods of time.  
This will prevent damage to the product due to lightning and power-line surges.
- 14) Refer all servicing to qualified service personnel. Servicing is required when the apparatus has been damaged in any way, such as power-supply cord or plug is damaged, liquid has been spilled or objects have fallen into the apparatus, the apparatus has been exposed to rain or moisture, does not operate normally, or has been dropped.
- 15) To prevent electric shock, ensure the grounding pin on the AC cord power plug is securely connected.



# Dear Panasonic Customer

Welcome to the Panasonic family of customers. We hope that you will have many years of enjoyment from your new Plasma Display.

To obtain maximum benefit from your set, please read these Instructions before making any adjustments, and retain them for future reference.

Retain your purchase receipt as well, and record the model number and serial number of your set in the space provided on the rear cover of these instructions.

## Table of Contents

<b>Important Safety Instructions</b> .....	<b>3</b>	<b>ADVANCED SETTINGS</b> .....	<b>23</b>
<b>FCC STATEMENT</b> .....	<b>5</b>	<b>PRESENT TIME SETUP/SET UP TIMER</b> .....	<b>24</b>
<b>Safety Precautions</b> .....	<b>6</b>	PRESENT TIME SETUP .....	24
<b>Accessories</b> .....	<b>8</b>	SET UP TIMER .....	25
Accessories Supplied .....	8	<b>SCREENSAVER (For preventing after-images)</b> .....	<b>26</b>
Remote Control Batteries .....	8	Setup of SCREENSAVER Time .....	27
<b>Connections</b> .....	<b>9</b>	Reduces screen after-image .....	27
PC Input Terminals connection .....	10	SIDE BAR ADJUST .....	28
SERIAL Terminals connection .....	11	<b>Digital Zoom</b> .....	<b>29</b>
AV & COMPONENT connection .....	12	<b>Reduces power consumption</b> .....	<b>30</b>
RGB signal (R, G, B, HD, VD) .....	12	Customizing the Input labels .....	30
<b>Power ON/OFF</b> .....	<b>13</b>	<b>SET UP for MULTI DISPLAY</b> .....	<b>31</b>
AC cord connection .....	13	How to setup MULTI DISPLAY .....	31
Power ON/OFF .....	13	How to set the Display location number for each Plasma Display .....	32
<b>Basic Controls</b> .....	<b>14</b>	<b>SET UP for Input Signals</b> .....	<b>33</b>
<b>On-Screen Menu Displays</b> .....	<b>16</b>	COMPONENT/RGB IN SELECT .....	33
<b>Input Signal Selection</b> .....	<b>18</b>	3D Y/C FILTER – For NTSC Video images .....	33
Select the Input Signal .....	18	COLOR SYSTEM / Panasonic AUTO .....	34
Selecting the ON-Screen Menu Language .....	18	3:2 PULLDOWN .....	34
<b>ASPECT Controls</b> .....	<b>19</b>	SYNC .....	35
<b>Adjusting PICTURE POSITION/SIZE</b> .....	<b>20</b>	H-FREQ. (kHz)/V-FREQ. (Hz) .....	35
<b>SOUND Adjustment</b> .....	<b>21</b>	<b>Troubleshooting</b> .....	<b>36</b>
MUTE .....	21	<b>VIDEO/COMPONENT/RGB/PC input signals</b> .....	<b>37</b>
<b>PICTURE Adjustments</b> .....	<b>22</b>	<b>Specifications</b> .....	<b>38</b>

# FCC STATEMENT

## FCC STATEMENT

This equipment has been tested and found to comply with the limits for a Class A digital device, pursuant to part 15 of the FCC Rules. These limits are designed to provide reasonable protection against harmful interference when the equipment is operated in a commercial environment.

This equipment generates, uses, and can radiate radio frequency energy and, if not installed and used in accordance with the instruction manual, may cause harmful interference to radio communications. Operation of this equipment in a residential area is likely to cause harmful interference in which case the user will be required to correct the interference at his own expense.

### **FCC CAUTION:**

**Pursuant to 47CFR, Part 15.21 of the FCC rules, any changes or modifications to this monitor not expressly approved by Matsushita Electric Corporation of America could cause harmful interference and would void the user's authority to operate this device.**

### **Attach the ferrite core:**

The ferrite cores provided as a supplied accessory must be used when connecting this Plasma Display to video equipment. (see page 10, 11)

### **FCC CAUTION:**

**To assure continued compliance and possible undesirable interference, the provided ferrite cores must be used when connecting this plasma display to video equipment; and maintain at least 40 cm of spacing from other peripheral devices. Refer to instructions on pages 10, and 11.**

---

### **CANADIAN NOTICE:**

This Class A digital apparatus complies with Canadian ICES-003.

### **Note:**

Do not allow a still picture to be displayed for an extended period, as this can cause permanent after-image to remain on the Plasma Display.

Examples of still pictures include logos, video games, computer images, teletext and images displayed in 4:3 mode.

### **Trademark Credits**

- VGA is a trademark of International Business Machines Corporation.
- Macintosh is a registered trademark of Apple Computer, USA.
- S-VGA is a registered trademark of the Video Electronics Standard Association.

Even if no special notation has been made of company or product trademarks, these trademarks have been fully respected.

# Safety Precautions

## **WARNING**

### **Set up**

**Do not place the Plasma Display on sloped or unstable surfaces.**

- The Plasma Display may fall off or tip over.

**Do not place any objects on top of the Plasma Display.**

- If water spills onto the Plasma Display or foreign objects get inside it, a short-circuit may occur which could result in fire or electric shock. If any foreign objects get inside the Plasma Display, please consult an Authorized Service Center.

**Do not cover the ventilation holes.**

- Doing so may cause the Plasma Display to overheat, which can cause fire or damage to the Plasma Display.

**If using the pedestal (optional accessory), leave a space of 3 <sup>15</sup>/<sub>16</sub>" (10 cm) or more at the top, left and right, 2 <sup>3</sup>/<sub>8</sub>" (6 cm) or more at the bottom, and 2 <sup>3</sup>/<sub>4</sub>" (7 cm) or more at the rear. If using some other setting-up method, leave a space of 3 <sup>15</sup>/<sub>16</sub>" (10 cm) or more at the top, bottom, left and right, and <sup>3</sup>/<sub>4</sub>" (1.9 cm) or more at the rear.**

**Avoid installing this product near electronic equipment that easily receives electromagnetic waves.**

- It may cause interference in image, sound, etc. In particular, keep video equipment away from this product.

### **AC Power Supply Cord**

**The Plasma Display is designed to operate on 120 V AC, 50/60 Hz.**

**Securely insert the power cord plug as far as it will go.**

- If the plug is not fully inserted, heat may be generated which could cause fire. If the plug is damaged or the wall socket plate is loose, they should not be used.

**Do not handle the power cord plug with wet hands.**

- Doing so may cause electric shocks.

**Do not do anything that might damage the power cable. When disconnecting the power cable, hold the plug, not the cable.**

- Do not make any modifications, place heavy objects on, place near hot objects, heat, bend, twist or forcefully pull the power cable. Doing so may cause damage to the power cable which can cause fire or electric shock. If damage to the cable is suspected, have it repaired at an Authorized Service Center.

**If the Plasma Display will not be used for a long period of time, unplug the power cord from the wall outlet.**

### **If problems occur during use**

**If a problem occurs (such as no picture or no sound), or if smoke or an abnormal odor is detected from the Plasma Display, unplug the power cord immediately.**

- Continuous use of the Display under these conditions might cause fire or permanent damage to the unit. Have the Display evaluated at an Authorized Service Center. Services to the Display by any unauthorized personnel are strongly discouraged due to its high voltage dangerous nature.

**If water or foreign objects get inside the Plasma Display, if the Plasma Display is dropped, or if the cabinet becomes damaged, disconnect the power cord plug immediately.**

- A short may occur, which could cause fire. Contact an Authorized Service Center for any repairs that need to be made.

## CAUTION

**This Plasma Display is for use only with the following optional accessories. Use with any other type of optional accessories may cause instability which could result in the possibility of injury.**

(All of the following accessories are manufactured by Matsushita Electric Industrial Co., Ltd.)

- Speakers ..... TY-SP37P5W-K (TH-37PWD6),  
TY-SP42P5W-K (TH-42PWD6, TH-42PHD6),  
TY-SP50P5W-K (TH-50PHD6)
- Pedestal ..... TY-ST05-K
- Wall stand ..... TY-ST42PW1
- Mobile stand ..... TY-ST42PF3 (TH-42PWD6, TH-42PHD6, TH-50PHD6)
- Wall-hanging bracket (vertical) ..... TY-WK37PV3 (TH-37PWD6),  
TY-WK42PV1 (TH-42PWD6, TH-42PHD6, TH-50PHD6)
- Wall-hanging bracket (angled) ..... TY-WK42PR1 (TH-42PWD6, TH-42PHD6, TH-50PHD6)
- Wall-hanging bracket (drawer type) ..... TY-WK42DR1 (TH-42PWD6, TH-42PHD6, TH-50PHD6)
- Ceiling unit ..... TY-CE42PS1
- BNC Component Video Terminal Board ..... TY-42TM6A
- BNC Composite Video Terminal Board ..... TY-42TM6B
- RCA Component Video Terminal Board ..... TY-42TM6Z
- RCA Composite Video Terminal Board ..... TY-42TM6V
- RGB (Digital) Terminal Board ..... TY-42TM6D
- RGB Active Through Terminal Board ..... TY-42TM6G
- PC Input Terminal Board ..... TY-42TM6P

Always be sure to ask a qualified technician to carry out set-up.

### When using the Plasma Display

**Do not bring your hands, face or objects close to the ventilation holes of the Plasma Display.**

- Top of the Plasma Display is usually very hot due to the high temperature of exhaust air being released through the ventilation holes. Burns or personal injuries can happen if any body parts are brought too close. Placing any object near the top of the display could also result in heat damages to the object as well as to the Display if its ventilation holes are blocked.

**Be sure to disconnect all cables before moving the Plasma Display.**

- Moving the Display with its cables attached might damage the cables which, in turn, can cause fire or electric shock.

**Disconnect the power plug from the wall outlet as a safety precaution before carrying out any cleaning.**

- Electric shocks can result if this is not done.

**Clean the power cable regularly to prevent it from becoming dusty.**

- Built-up dust on the power cord plug can increase humidity which might damage the insulation and cause fire. Unplug the cord from the wall outlet and clean it with a dry cloth.

**This Plasma Display radiates infrared rays, therefore it may affect other infrared communication equipment.**

**Install your infrared sensor in a place away from direct or reflected light from your Plasma Display.**

## Cleaning and maintenance

**The front of the display panel has been specially treated. Wipe the panel surface gently using only a cleaning cloth or a soft, lint-free cloth.**

- If the surface is particularly dirty, soak a soft, lint-free cloth in a weak detergent solution and then wring the cloth to remove excess liquid. Use this cloth to wipe the surface of the display panel, then wipe it evenly with a dry cloth, of the same type, until the surface is dry.
- Do not scratch or hit the surface of the panel with fingernails or other hard objects. Furthermore, avoid contact with volatile substances such as insect sprays, solvents and thinner, otherwise the quality of the surface may be adversely affected.

**If the cabinet becomes dirty, wipe it with a soft, dry cloth.**

- If the cabinet is particularly dirty, soak the cloth in a weak detergent solution and then wring the cloth dry. Use this cloth to wipe the cabinet, and then wipe it dry with a dry cloth.
- Do not allow any detergent to come into direct contact with the surface of the Plasma Display. If water droplets get inside the unit, operating problems may result.
- Avoid contact with volatile substances such as insect sprays, solvents and thinner, otherwise the quality of the cabinet surface may be adversely affected or the coating may peel off. Furthermore, do not leave it for long periods in contact with articles made from rubber or PVC.

### Note:

Do not allow a still picture to be displayed for an extended period, as this can cause a permanent after-image to remain on the Plasma Display. Examples of still pictures include logos, video games, computer images, teletext and images displayed in 4:3 mode.

# Accessories

## Accessories Supplied

Check that you have the Accessories and items shown

Operating Instruction book

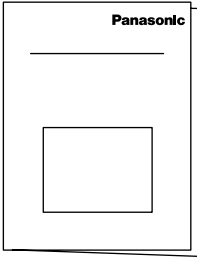

Remote Control Transmitter EUR646529

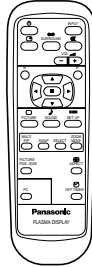

Batteries for the Remote Control Transmitter (AA Battery × 2)

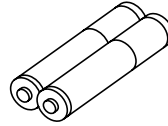

Warranty

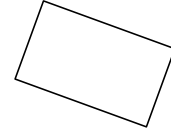

Ferrite core (small size)

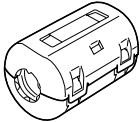

Ferrite core (large size)

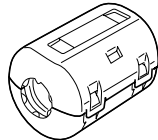

Fixing bands

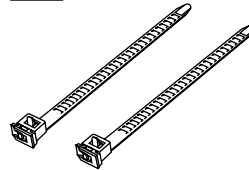

AC cord

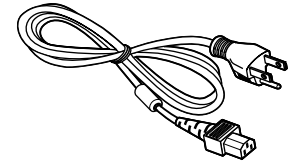

## Remote Control Batteries

Requires two AA batteries.

1. Turn the transmitter face down. Press and slide off the battery cover.

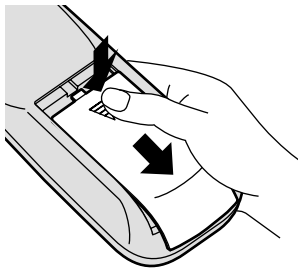

2. Install the batteries as shown in the battery compartment. (Polarity + or – must match the markings in the compartment.)

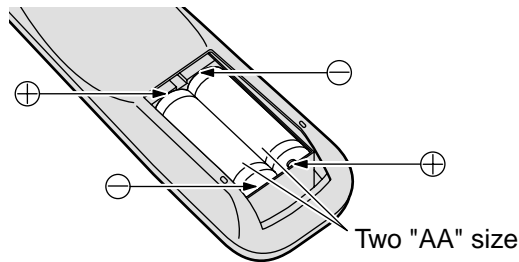

3. Replace the cover and slide in reverse until the lock snaps.

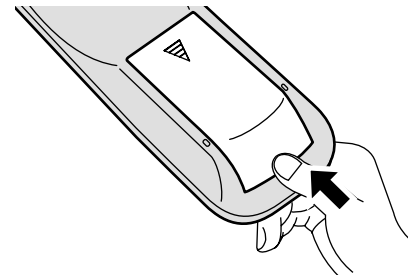

### Helpful Hint:

For frequent remote control users, replace old batteries with Alkaline batteries for longer life.

### ⚠ Precaution on battery use

Incorrect installation can cause battery leakage and corrosion that will damage the remote control transmitter.

**Observe the following precautions:**

1. Batteries should always be replaced as a pair. Always use new batteries when replacing the old set.
2. Do not combine a used battery with a new one.
3. Do not mix battery types (example: "Zinc Carbon" with "Alkaline").
4. Do not attempt to charge, short-circuit, disassemble, heat or burn used batteries.
5. Battery replacement is necessary when the remote control acts sporadically or stops operating the Plasma Display.



# Connections

When connecting the speakers, be sure to use only the optional accessory speakers. Refer to the speaker's Installation Manual for details on speaker installation.

(Example : TH-42PWD6) Speakers (Optional accessories)

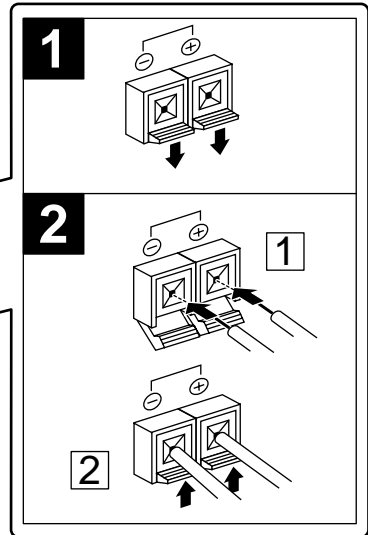
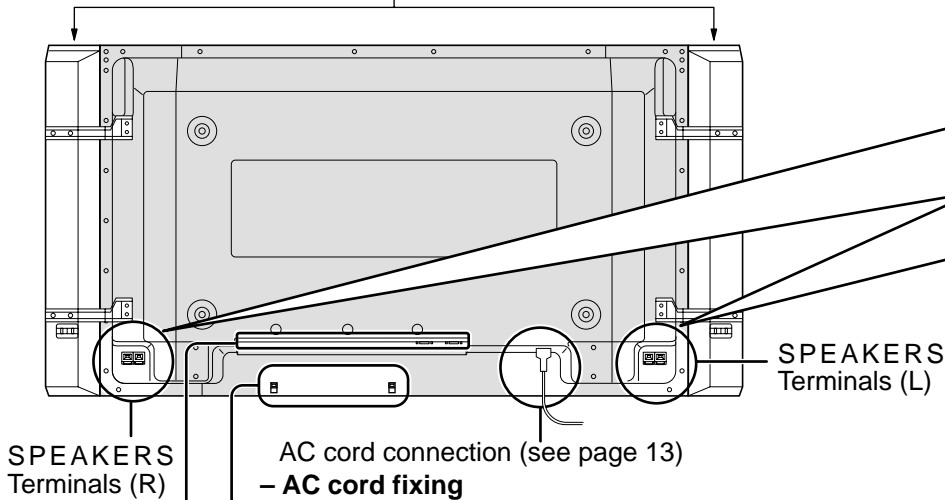

## - AC cord fixing

1. Open the clamber.

2. Insert the AC cord and close the clamber securely.

3. Slide up the clamber and fix the AC cord plug securely.

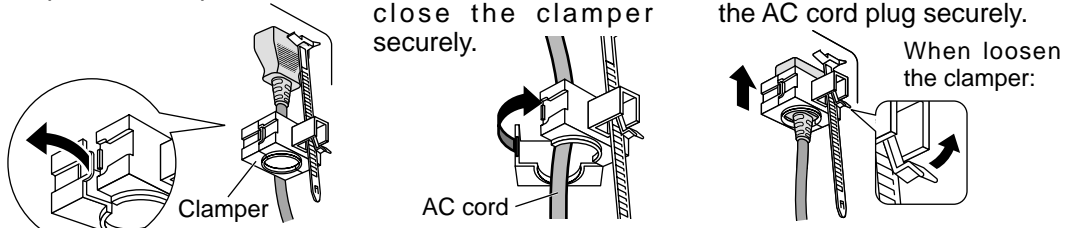

**Note:** The power plug in the illustration may not be the type fitted to your set.

## - Cable fixing bands

Secure any excess cables with bands as required.

Pass the attached cable fixing band through the clip as shown in the figure.

To secure cables connected to Terminals, wrap the cable fixing band around them then pass the pointed end through the locking block, as shown in the figure.

**While ensuring there is sufficient slack in cables to minimize stress (especially in the power cord), firmly bind all cables with the supplied fixing band.**

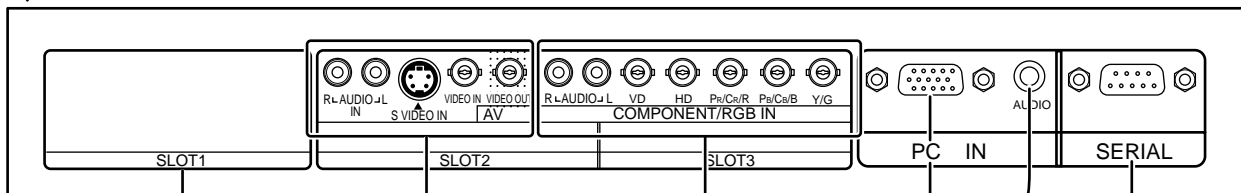
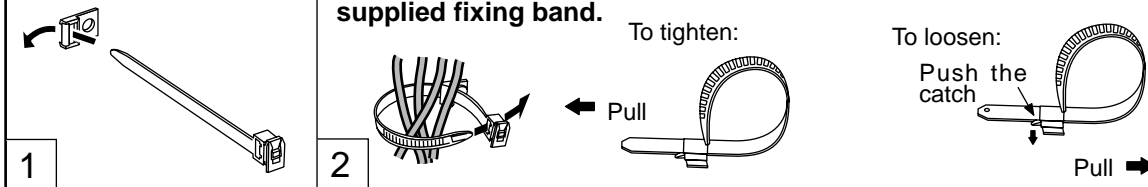

Optional Terminal Board Insert Slot (covered)

AV Terminals (see page 12)

COMPONENT/RGB IN and Audio IN Terminals (see page 12)

From EXTERNAL monitor terminal on Computer (see page 10)

From SERIAL Terminal on Computer (see page 11)

**Note:** At factory shipment, Terminal boards are installed in SLOT 2 and SLOT 3. TH-37PWD6 has 2 SLOTS only.

## PC Input Terminals connection

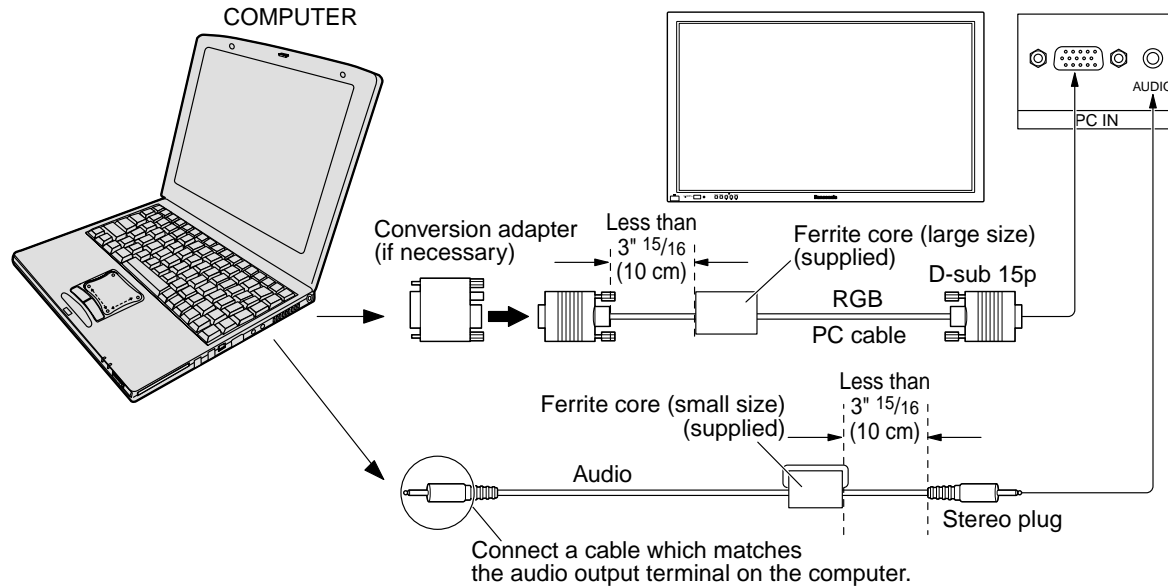

### Installing the ferrite core (Small size)

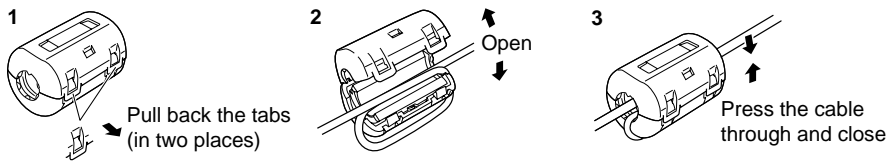

### Installing the ferrite core (Large size)

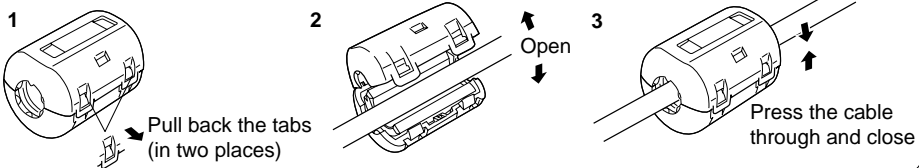

### Notes:

- (1) Computer signals which can be input are those with a horizontal scanning frequency of 15 to 110 kHz and vertical scanning frequency of 48 to 120 Hz. (However, the image will not be displayed properly if the signals exceed 1,200 lines.)
- (2) The display resolution is a maximum of 640 × 480 dots (TH-37PWD6, TH-42PWD6), 768 × 768 dots (TH-42PHD6), 1,024 × 768 dots (TH-50PHD6) when the aspect mode is set to "4:3", and 852 × 480 dots (TH-37PWD6, TH-42PWD6), 1,024 × 768 dots (TH-42PHD6), 1,366 × 768 dots (TH-50PHD6) when the aspect mode is set to "16:9". If the display resolution exceeds these maximums, it may not be possible to show fine detail with sufficient clarity.
- (3) The PC input terminals are DDC1/2B-compatible. If the computer being connected is not DDC1/2B-compatible, you will need to make setting changes to the computer at the time of connection.
- (4) Some PC models cannot be connected to the set.
- (5) There is no need to use an adapter for computers with DOS/V compatible D-sub 15P terminal.
- (6) The computer shown in the illustration is for example purposes only.
- (7) Additional equipment and cables shown are not supplied with this set.
- (8) Do not set the horizontal and vertical scanning frequencies for PC signals which are above or below the specified frequency range.
- (9) Component Input is possible with the pin 1,2,3 of the D-sub 15P Connector.

### Signal Names for D-sub 15P Connector

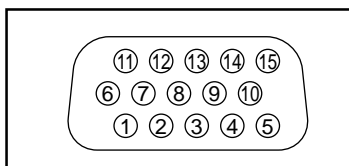

Pin Layout for PC Input Terminal

Pin No.	Signal Name	Pin No.	Signal Name	Pin No.	Signal Name
①	R (P <sub>R</sub> /C <sub>R</sub> )	⑥	GND (Ground)	⑪	GND (Ground)
②	G(Y)	⑦	GND (Ground)	⑫	SDA
③	B(P <sub>B</sub> /C <sub>B</sub> )	⑧	GND (Ground)	⑬	HD/SYNC
④	GND (Ground)	⑨	NC (not connected)	⑭	VD
⑤	GND (Ground)	⑩	GND (Ground)	⑮	SCL

# SERIAL Terminals connection

The SERIAL terminal is used when the Plasma Display is controlled by a computer.

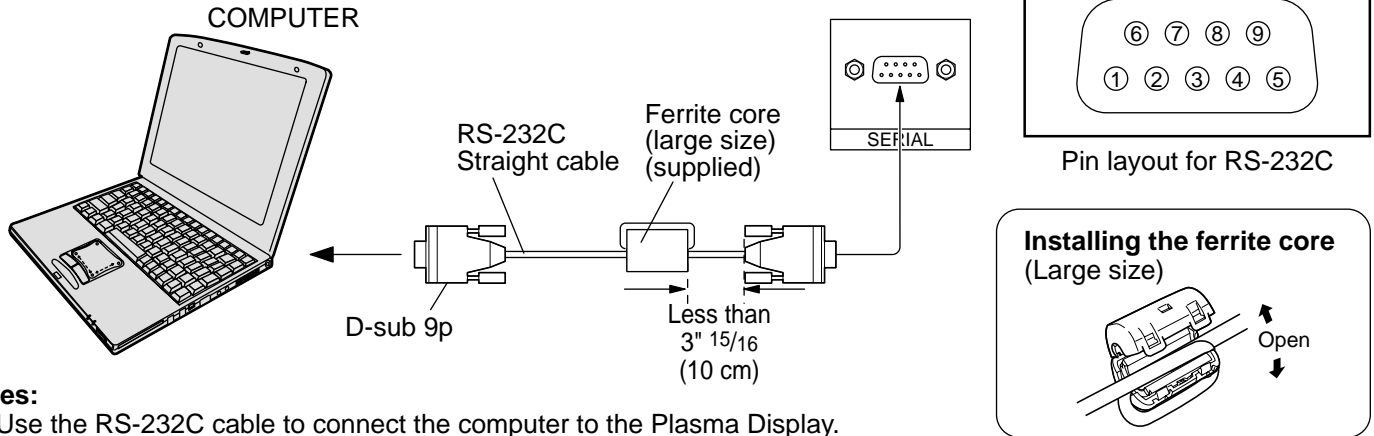

**Notes:**

- (1) Use the RS-232C cable to connect the computer to the Plasma Display.
- (2) The computer shown is for example purposes only.
- (3) Additional equipment and cables shown are not supplied with this set.

The SERIAL terminal conforms to the RS-232C interface specification, so that the Plasma Display can be controlled by a computer which is connected to this terminal.

The computer will require software which allows the sending and receiving of control data which satisfies the conditions given below. Use a computer application such as programming language software. Refer to the documentation for the computer application for details.

**Communication parameters**

Signal level	RS-232C compliant
Synchronization method	Asynchronous
Baud rate	9600 bps
Parity	None
Character length	8 bits
Stop bit	1 bit
Flow control	-

RS-232C Conversion cable	
D-sub 9-pin female	Details
②	R X D
③	T X D
⑤	GND
④ • ⑥	Non use
⑦	Shorted
⑧	
① • ⑨	NC

**Basic format for control data**

The transmission of control data from the computer starts with a STX signal, followed by the command, the parameters, and lastly an ETX signal in that order. If there are no parameters, then the parameter signal does not need to be sent.

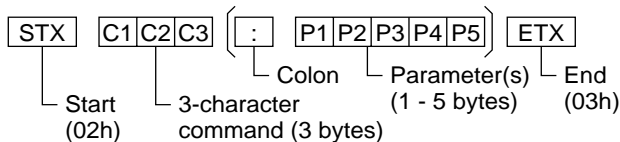

**Notes:**

- (1) If multiple commands are transmitted, be sure to wait for the response for the first command to come from this unit before sending the next command.
- (2) If an incorrect command is sent by mistake, this unit will send an "ER401" command back to the computer.

**Command**

Command	Parameter	Control details
PON	None	Power ON
POF	None	Power OFF
AVL	**	Volume 00 - 63
AMT	0	Audio MUTE OFF
	1	Audio MUTE ON
IMS	None	Input select (toggle)
	SL1	Slot1 input
	SL2	Slot2 input
	SL3	Slot3 input
	PC1	PC input
DAM	None	Screen mode select (toggle)
	NORM	NORMAL (4:3)
	ZOOM	ZOOM
	FULL	FULL
	JUST	JUST
	SELF	Panasonic AUTO

With the power off, this display responds to PON command only.

## AV & COMPONENT Connection

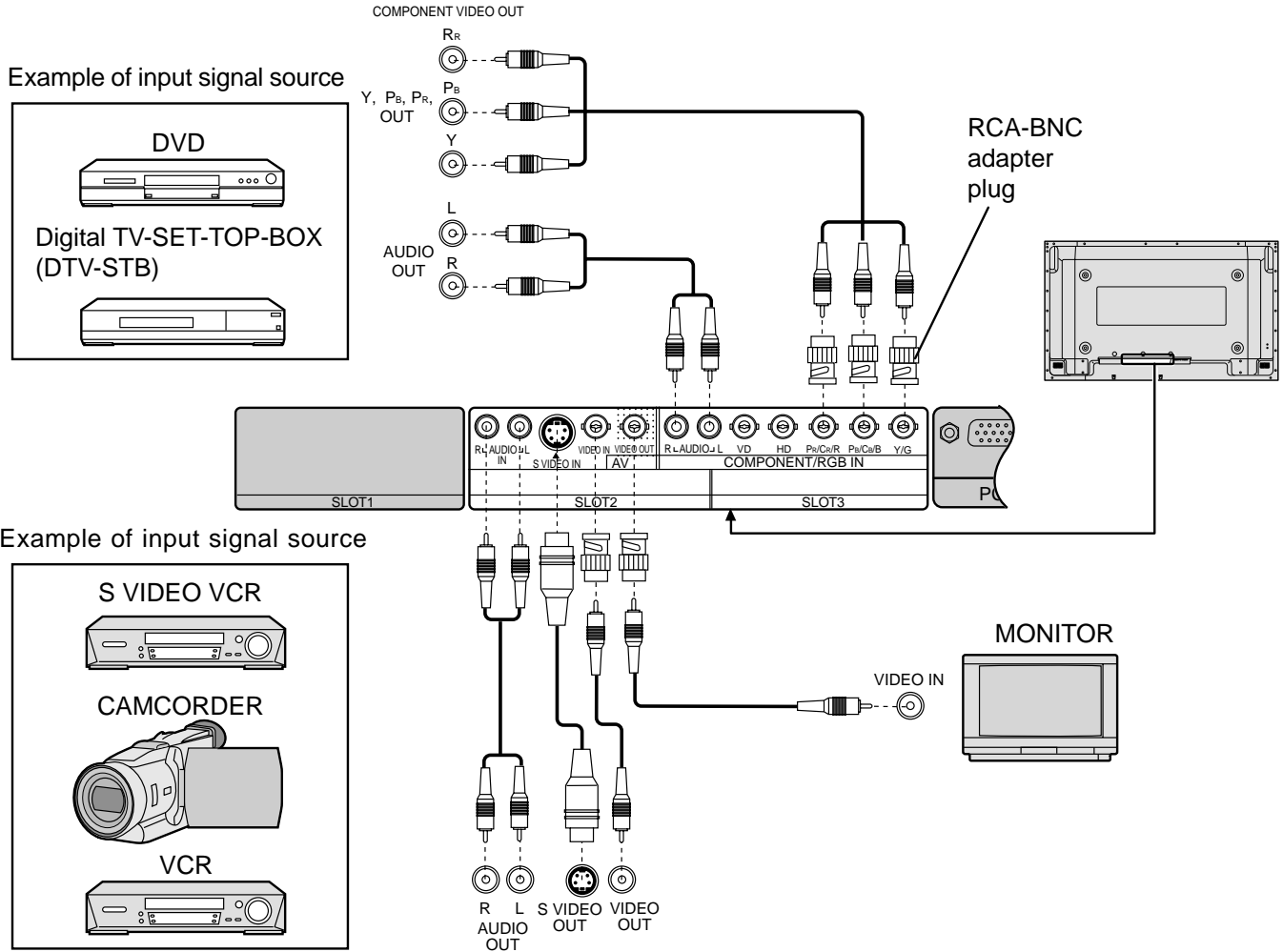

**Notes:**

- (1) Change the "Component/RGB-in" setting in the "Setup" menu to "Component". (see page 33)
- (2) Additional equipment, cables and adapter plugs shown are not supplied with this set.

## RGB signal (R, G, B, HD, VD)

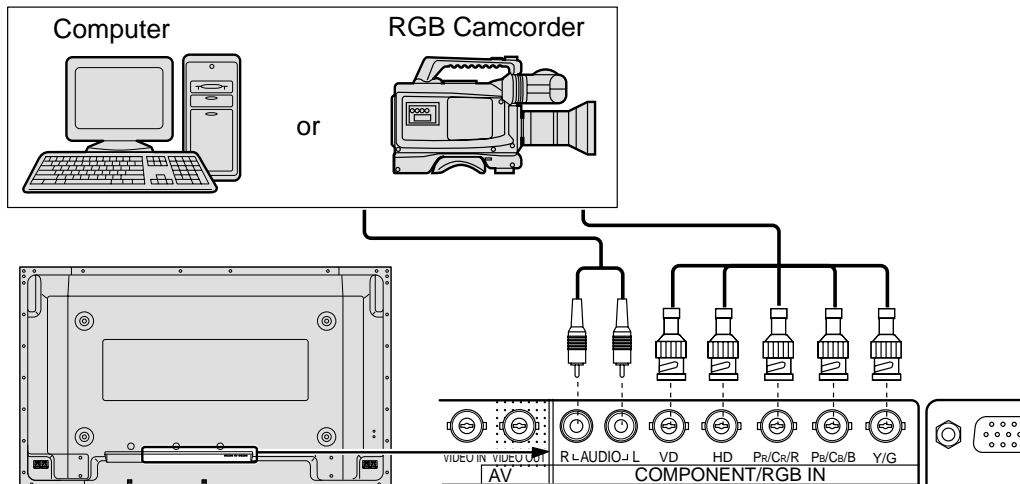

**Notes:**

- (1) Change the "Component/RGB-in" setting in the "Setup" menu to "RGB". (see page 33)
- (2) Additional equipment, cables and adapter plugs shown are not supplied with this set.

# Power ON/OFF

## AC cord connection

Connecting the AC cord plug to the Plasma Display.

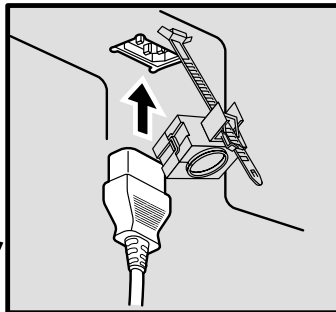
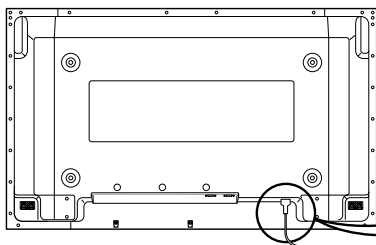

Fix the AC cord plug securely to the Plasma Display with the clamber. (See page 9)

## Power ON/OFF

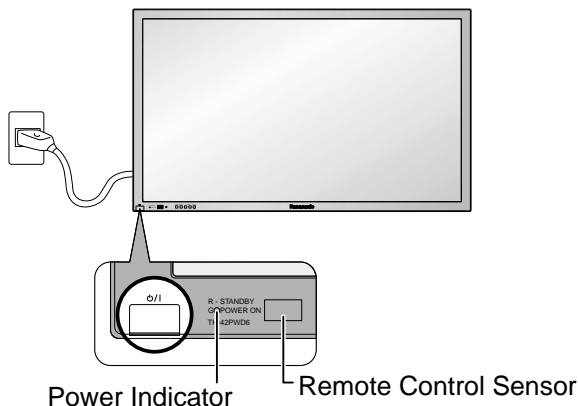

### Connecting the plug to the Wall Outlet

Press the POWER switch on the Plasma Display to turn the set on : POWER-ON.

Power Indicator : Green

Example: The screen below is displayed for a while after the Plasma Display is turned on. (setting condition is an example.)

When the POWER is turned on for the first time, the LANGUAGE selection screen is displayed.

From the second time on, language selection can be done from the setup menu. (see page 18)

Select the desired language using the ▲ and ▼ keys and press the ACTION button.

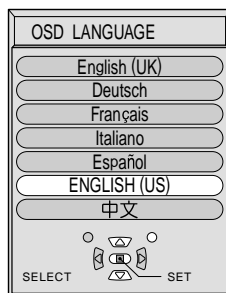

From the second time on, the screen shown below is displayed for a while (setting condition is an example).

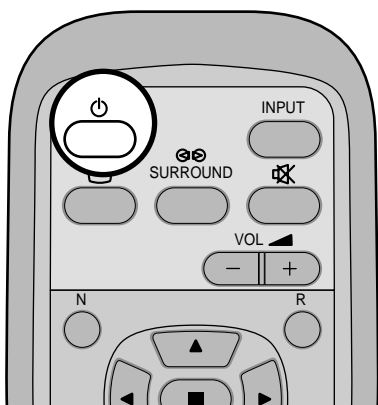
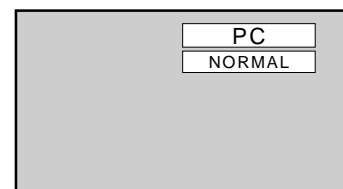

Press the  button on the remote control to turn the Plasma Display off.

Power Indicator: Red (STAND-BY)

Press the  button on the remote control to turn the Plasma Display on.

Power Indicator: Green

To turn the power for the Plasma Display off, press the  switch on the Plasma Display, when the Plasma Display is on or in standby mode.

**Note:** During operation of the power management function, the power indicator turns orange in the power off state.

# Basic Controls

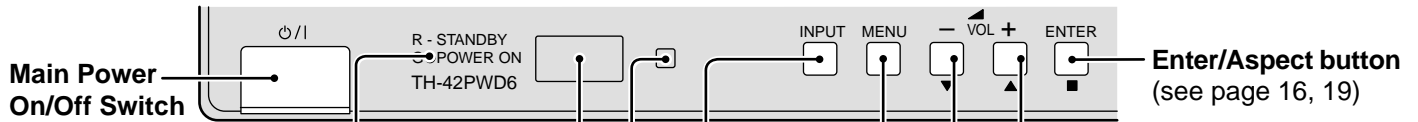

**Power Indicator**  
The Power Indicator will light.

- Power-OFF .. Indicator not illuminated (The unit will still consume some power as long as the power cord is still inserted into the wall outlet.)
- Stand-by  $\phi$  .... Red
- Power-ON ..... Green
- DPMS ..... Orange [With PC input signal and during operation of PC's screensaver.]

**C.A.T.S sensor**  
**Plasma C.A.T.S (Contrast Automatic Tracking System)**  
Plasma C.A.T.S automatically senses the ambient light conditions and adjusts the brightness and gradation accordingly, to optimise contrast. (Effective when Picture mode is set to Auto.)

**MENU Screen ON/OFF**  
Each time the MENU button is pressed, the menu screen will switch. (see page 16)



**INPUT button**  
(INPUT1, INPUT2, INPUT3 and PC IN Selection)  
(see page 18)

**Volume Adjustment**  
Volume Up “+” Down “-”  
When the menu screen is displayed.  
“+”: press to move the cursor up  
“-”: press to move the cursor down  
(see page 16)

**Status button**  
Press the “Status” button to display the current system status.

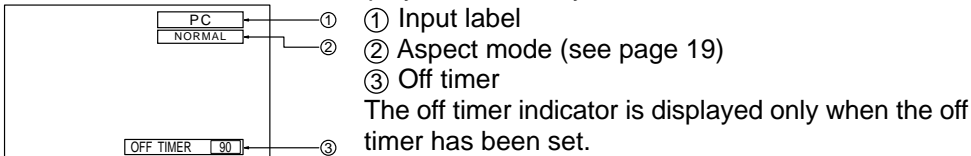

**N button**  
(see page 20, 21, 22, 23)

**PICTURE button**  
(see page 22)

## MULTI PIP

Each time pressing this button main picture and sub picture will be displayed as follows bellow.

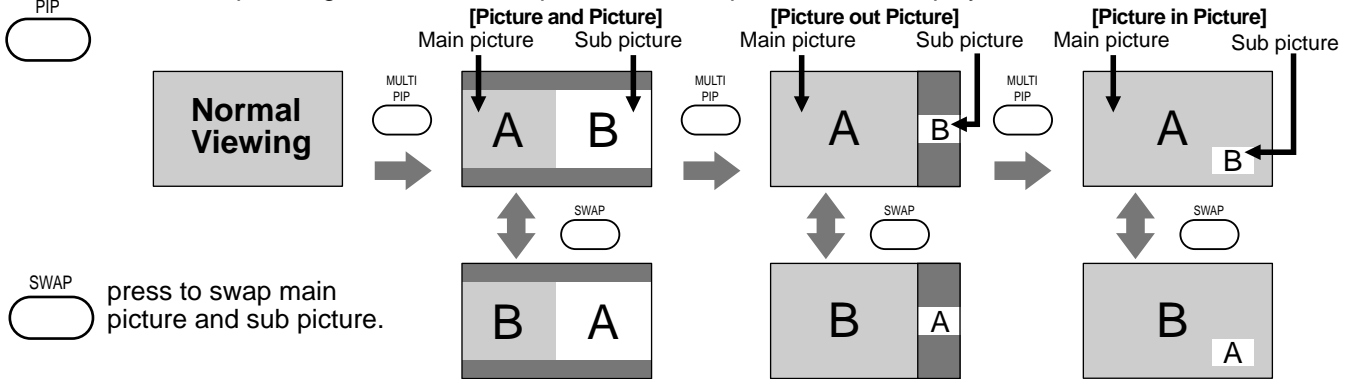

**SELECT**  
Press the SELECT button  
Under the main Picture and sub picture display, select the picture which you would like to change input modes.

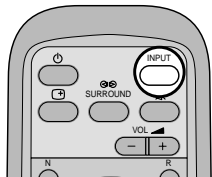

**INPUT**  
Press to change input signal.

**ZOOM MOVE**  
Press the MOVE button  
Each time the location of the sub picture will be moved.

- Notes:** (1) This button is effective only in the picture in picture.  
(2) The sub picture may be hidden by the on screen display, depending on its position.

**Note:** Sound output is from the main picture.

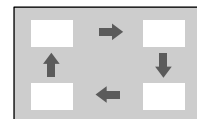
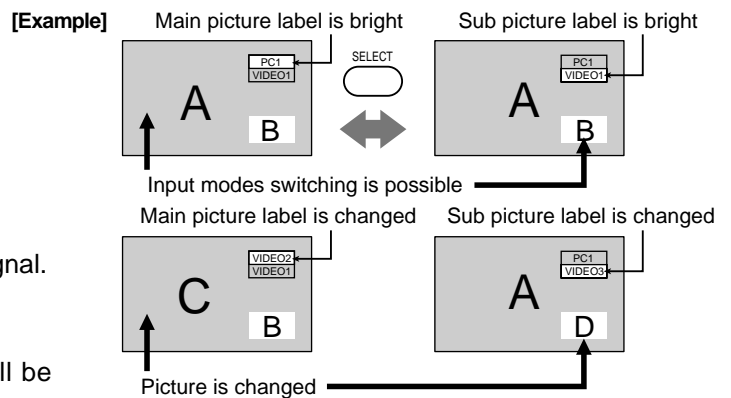

## Stand-by (ON/OFF) button

The Plasma Display must first be plugged into the wall outlet and turned on at the power switch (see page 13). Press this button to turn the Plasma Display On, from Standby mode. Press it again to turn the Plasma Display Off to Standby mode.

## SURROUND Button

The benefits of surround sound are enormous. You can be completely enveloped in sound; just as if you were at a concert hall or cinema.

The surround setting switches on and off each time the SURROUND button is pressed.

ON ← → OFF

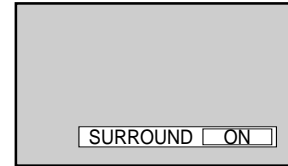

### Note:

The surround settings are memorized separately for each Sound mode (Normal, Auto).

## INPUT button

(INPUT1, INPUT2, INPUT3 and PC IN Selection)

Press to select INPUT1, INPUT2, INPUT3 and PC IN input SLOTS sequentially. (see page 18)

Sound mute On/Off (see page 21)

## Volume Adjustment

Press the Volume Up "+" or Down "-" button to increase or decrease the sound volume level.

R button (see page 20-21)

Press the R button to return to previous menu screen.

## ACTION button

Press to make selections.

## POSITION buttons

SOUND button (see page 21)

Press to adjust the SOUND.

SET UP button (see page 16)

Digital Zoom(see page 29)



Press to access Digital Zoom.

This displays an enlargement of the designated part of the displayed image.

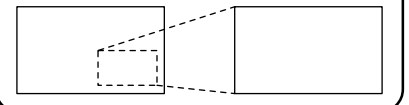

PICTURE POS./SIZE button (see page 20)

## ASPECT button

Press to adjust the aspect. (see page 19)

## OFF TIMER button

The Plasma Display can be preset to switch to stand-by after a fixed period. The setting changes to 30 minutes, 60 minutes, 90 minutes and 0 minutes (off timer cancelled) each time the button is pressed.

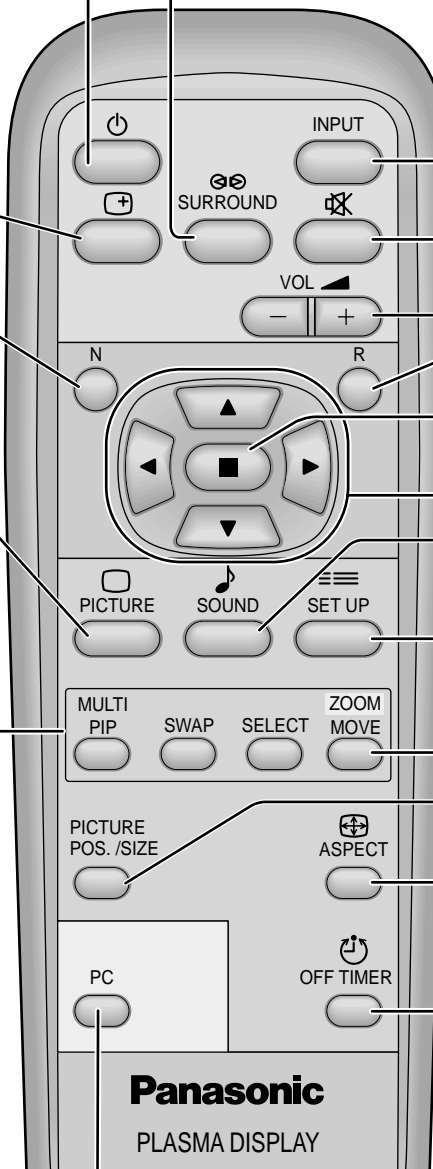
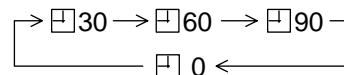

## PC button

Press the "PC" input mode selection button to select the PC input mode.

This button is used to switch directly to PC input mode.

**Note:** In 2 screen display, the same input mode cannot be selected for the main picture and sub picture.

When three minutes remain, "Off timer 3" will flash. The off timer is cancelled if a power interruption occurs.

# On-Screen Menu Displays

To PICTURE adjust menu  
(see page 22)

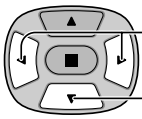
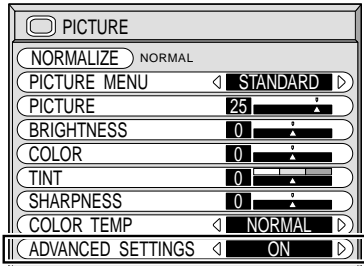

Press to select  
"ON".  
Press to enter  
ADVANCED  
SETTINGS.

To ADVANCED SETTINGS  
(see page 22, 23)

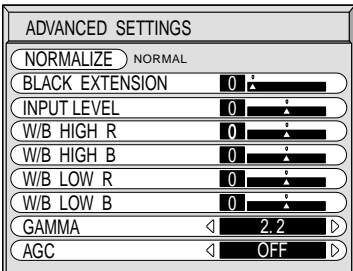

To SOUND adjust menu  
(see page 21)

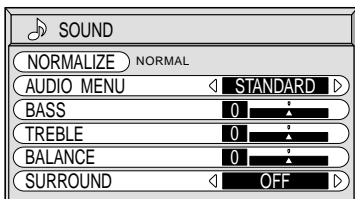

To PICTURE POS./SIZE adjust menu (see page 20)

During "VIDEO (S VIDEO)" and  
"COMPONENT" input signal.

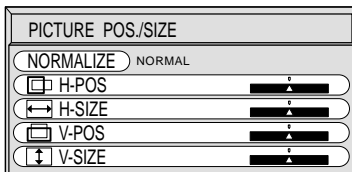

During "RGB/PC" and "DVI"  
input signal .

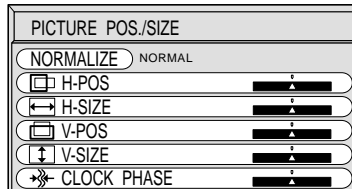

The MENU button on the unit can also  
be pressed.

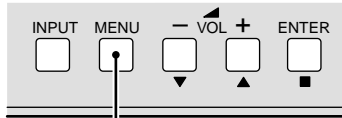

Each time the MENU button is pressed,  
the menu screen will switch.

Normal Viewing → PICTURE → SET UP  
SOUND ← PICTURE POS./ SIZE ←

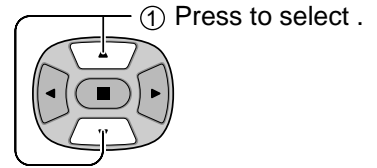
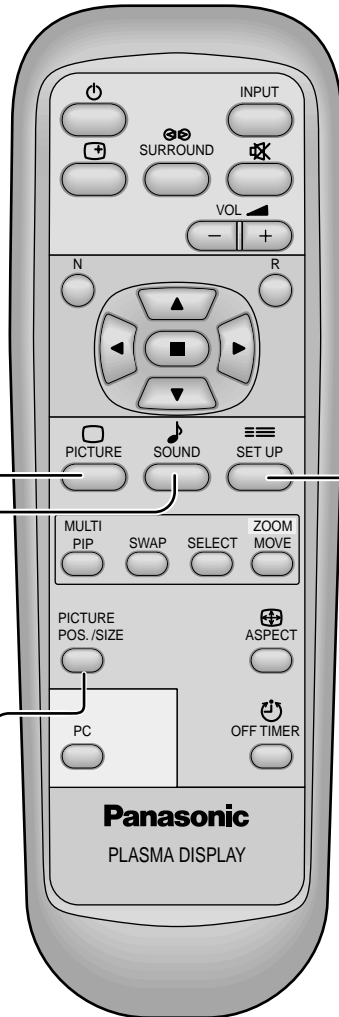

[ from the unit ]

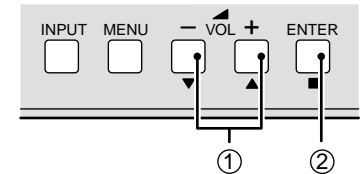

① Press to select.  
② Press to access each adjust  
screen.

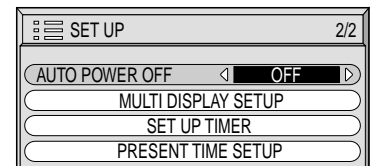
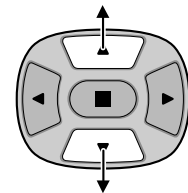
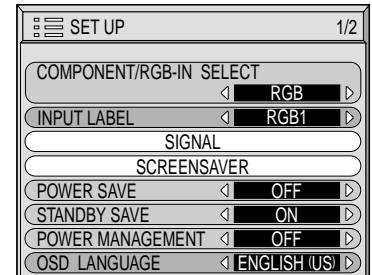



# On-Screen Menu Display from Remote Control

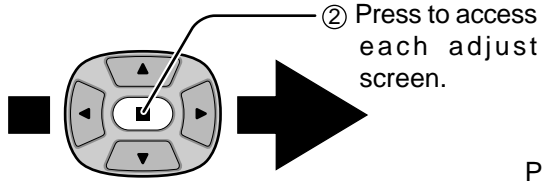

[ from the unit ]

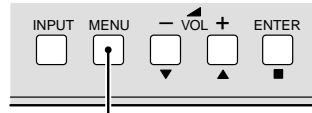

Press to return to previous menu screen.

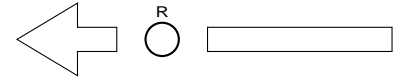

Press the R button to return to previous menu.

To SIGNAL screen for VIDEO (S VIDEO) (see page 33, 34)

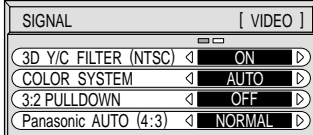

To SIGNAL screen for COMPONENT (see page 34)

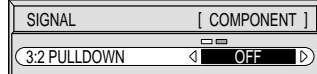

To SIGNAL screen for RGB and DVI (see page 35)

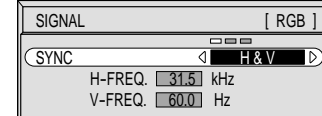

**Note:** "SIGNAL" setup menu displays a different setting condition for each input signal. (see page 18)

To setup SCREENSAVER (See page 26-28)

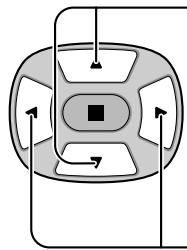
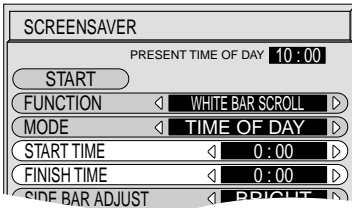

Press to select START TIME/ FINISH TIME (When TIME OF DAY is selected).  
Press to select SHOW DURATION/ SAVER DURATION (When INTERVAL is selected).

Press to set up.

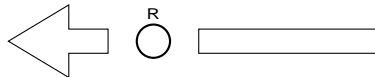
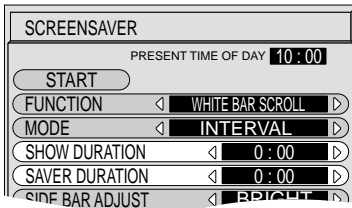
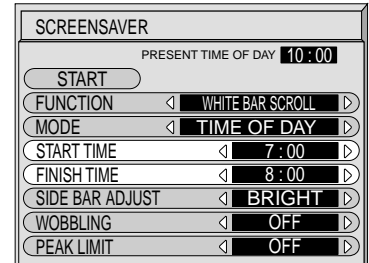

Press the R button to return to "SCREENSAVER" menu.

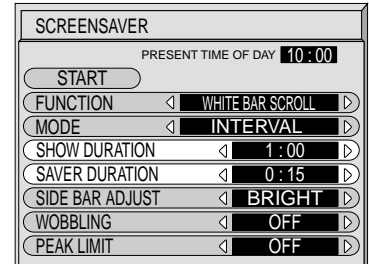

To setup MULTIDISPLAY screen. (See page 31)

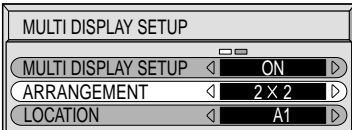

To SET UP TIMER selection screen. (see page 24-25)

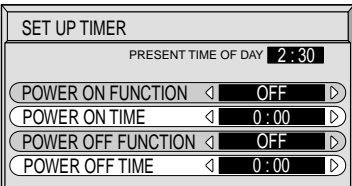

Press to select POWER ON TIME / POWER OFF TIME.

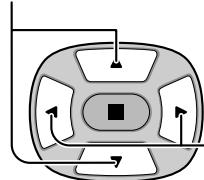

Press to set up POWER ON TIME/ POWER OFF TIME.

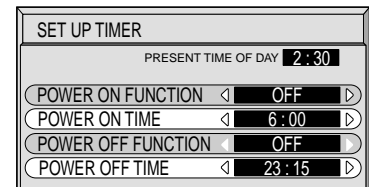

To PRESENT TIME SET UP. (see page 24)

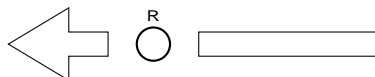
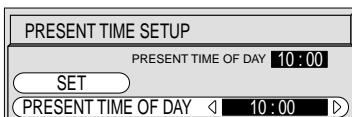

Press the R button to return to "SET UP TIMER" menu.

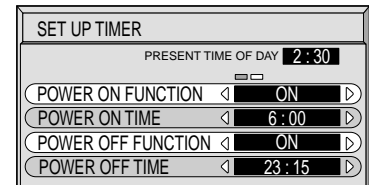

# Input Signal Selection

## Select the Input Signal

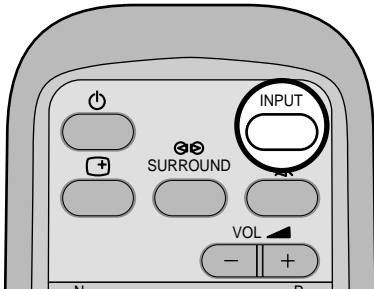
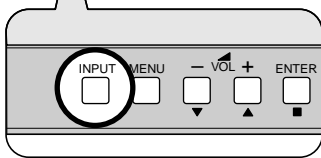

Press the INPUT button to select the input signal to be played back from the equipment which has been connected to the Plasma Display.

Input signals will change as follows:

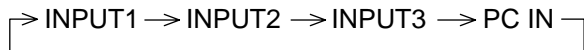

### Notes:

- (1) Input terminal will not be selected if the terminal board is not installed into the SLOT.
- (2) Select to match the signals from the source connected to the component/RGB input terminals. (see page 33)
- (3) In 2 screen display, the same input mode cannot be selected for the main picture and sub picture.

## Selecting the On-Screen Menu Language

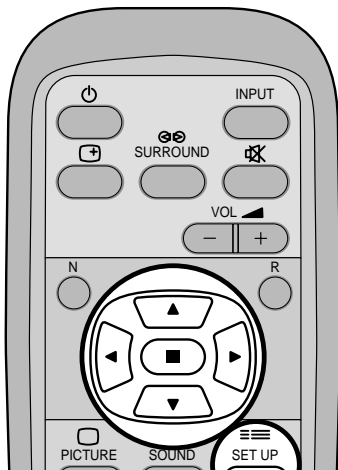

press to display the SET UP menu.

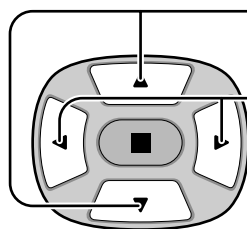

press to select OSD LANGUAGE.

press to select your preferred language.

Selectable languages

- ENGLISH(UK)
- Deutsch
- Français
- Italiano
- Español
- ENGLISH(US)
- 中文 .....(Chinese)

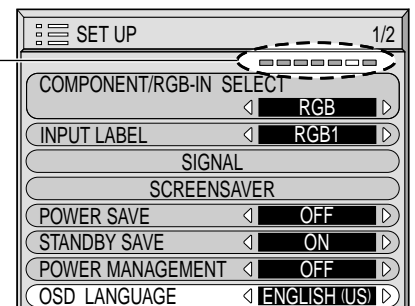

# ASPECT Controls

The Plasma Display will allow you to enjoy viewing the picture at its maximum size, including wide screen cinema format picture.

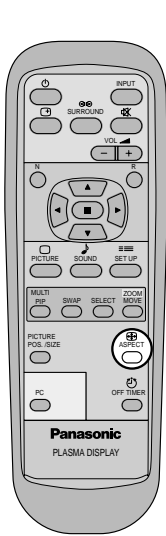

## ASPECT button

The aspect mode changes each time the ASPECT button is pressed.

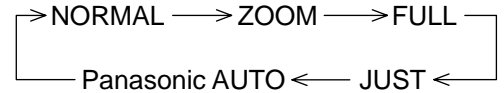

[from the unit]

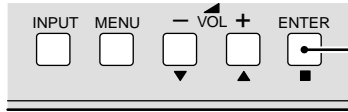

The aspect mode changes each time the ENTER button is pressed.

[During MULTI PIP Operations]

(1) Picture and Picture, Picture in Picture :

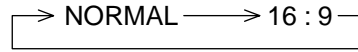

(2) Others :

Aspect switching is not possible.

## Notes:

- For PC signal input, the mode switches between "NORMAL", "ZOOM" and "FULL" only.
- For a 1125 (1080) / 60i · 50i · 24p · 24sF, 1250 (1080) / 50i, 750 (720) / 60p · 50p signal input during "COMPONENT", "RGB" and "DVI" input signal mode, the mode is set to "FULL" mode, and switching is not possible.  
Panasonic Auto can be selected only during Video signal input.
- The aspect mode is memorized separately for each input terminal (INPUT1, INPUT2, INPUT3 and PC IN).

Mode	Picture	Explanation
NORMAL		NORMAL will display a 4:3 picture at its standard 4:3 size.
ZOOM		ZOOM mode magnifies the central section of the picture.
FULL		16:9 will display the picture at its maximum size but with slight elongation.
JUST		JUST mode will display a 4:3 picture at its maximum size but with aspect correction applied to the center of the screen so that elongation is only apparent at the left and right edges of the screen. The size of the picture will depend on the original signal.
Panasonic AUTO	 For an elongated image Image is expanded  Changes in accordance with the Panasonic AUTO mode setting (see page 34).	The display will automatically become enlarged (depending on the picture source), allowing you to view the picture at its maximum size.  <b>Note:</b> Panasonic AUTO mode is designed to automatically adjust the aspect ratio to handle a mix of 16:9 and 4:3 program material. Certain 4:3 program material, such as stock market data screens, may occasionally cause the image size to change unexpectedly. When viewing such programs, it is recommended that the ASPECT be set to NORMAL.

## Note:

Do not allow the picture to be displayed in 4:3 mode for an extended period, as this can cause a permanent after-image to remain on the Plasma Display Panel.

# Adjusting PICTURE POSITION/SIZE

## Adjusting screen

1

PICTURE POS./SIZE



Press to display the PICTURE POS./SIZE menu.

2

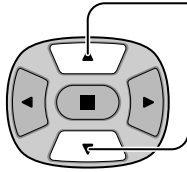

Press to select H-POS/H-SIZE/V-POS/V-SIZE/CLOCK PHASE.

During "VIDEO (S VIDEO)" and "COMPONENT" input signal.

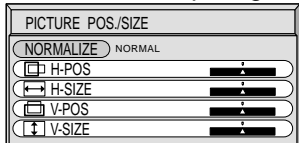

During "RGB/PC" and "DVI" input signal.

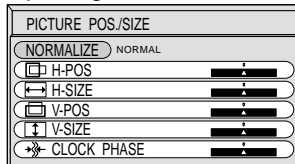

3

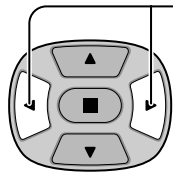

Press to adjust POS./SIZE.



Press to exit from adjust mode.

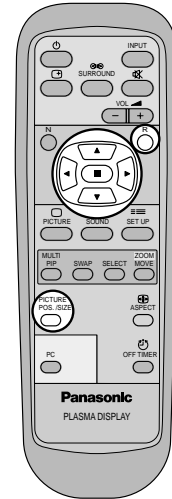

### Notes:

- Adjustment details are memorized separately for different input signal formats (Adjustments for component signals are memorized for 525 (480) / 60i · 60p, 625 (575) / 50i · 50p, 1125 (1080) / 60i · 50i · 24p · 24sF, 1250 (1080) / 50i, 750 (720) / 60p · 50p each, and RGB/PC/DVI signals are memorized for each frequency.)
- If a "Cue" or "Rew" signal from a VCR or DVD player is received, the picture position will shift up or down. This picture position movement cannot be controlled by the PICTURE POS./SIZE function.

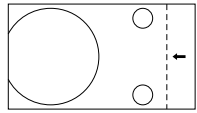
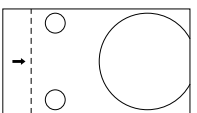
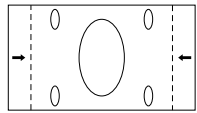
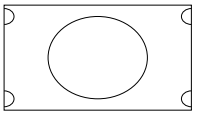
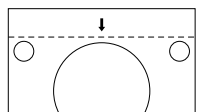
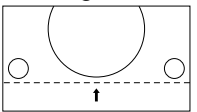
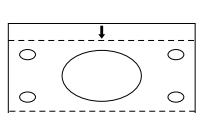
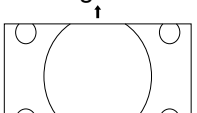
<b>H-POS</b>	When the Position Left "◀" button is pressed 	When the Position Right "▶" button is pressed 
<b>H-SIZE</b>	When the Position Left "◀" button is pressed 	When the Position Right "▶" button is pressed 
<b>V-POS</b>	When the Position Left "◀" button is pressed 	When the Position Right "▶" button is pressed 
<b>V-SIZE</b>	When the Position Left "◀" button is pressed 	When the Position Right "▶" button is pressed 
<b>CLOCK PHASE (RGB/PC in Mode)</b>	Flickering and distortion can be eliminated by using the Position Left "◀" or Right "▶" button to carry out adjustment.	

## Helpful Hint ( / Normalization )

While the PICTURE POS./SIZE display is active, if either the N button on the remote control is pressed at any time or the  (ACTION button) is pressed during "NORMALIZE", then all adjustment values are returned to the factory settings.

# SOUND Adjustment

**1**  Press to display the Sound menu.

**2** Select to adjust each item.

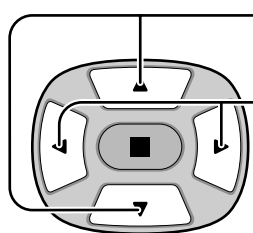
 Press to select the desired adjustment menu.  
Select the desired level by listening to the sound.

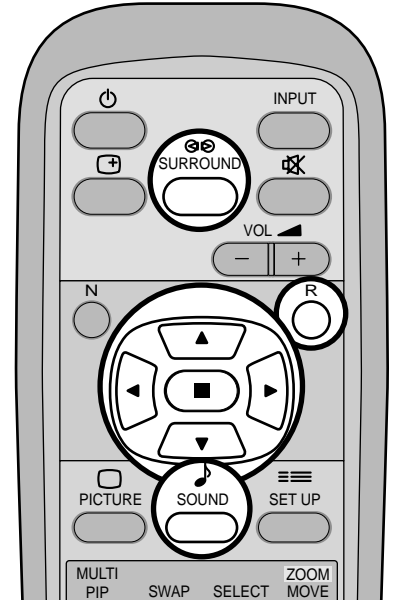

**BASS**  
Adjusts low sounds

**TREBLE**  
Adjusts high sounds

**BALANCE**  
Adjusts left and right volumes

**SURROUND**  
Select ON or OFF

• To end adjustments

 Press the R button

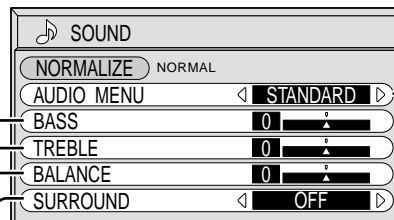

**STANDARD** Emits the original sound.



**AUTO** Automatically controls proper volume level.

## Note:

Press the SURROUND button to directly turn the surround effect ON and OFF. (see page 15)

BASS, TREBLE and SURROUND settings are memorized separately for each SOUND mode (STANDARD, AUTO).

## Helpful Hint ( / Normalization )

While the "SOUND" menu is displayed, if either the N button on the remote control is pressed at any time or the  (ACTION button) is pressed during "NORMALIZE", then all adjustment values are returned to the factory settings.

## MUTE

Useful when answering the phone or receiving visitors.

 Press this button to mute the sound.  
Press again to reactivate sound. Sound is also reactivated when power is turned off or volume level is changed.

# PICTURE Adjustments

**1**  Press to display the PICTURE menu.

**2** Select to adjust each item.

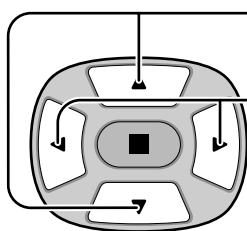
 Press to select the menu to adjust.  
Select the desired level by looking at the picture behind the menu.

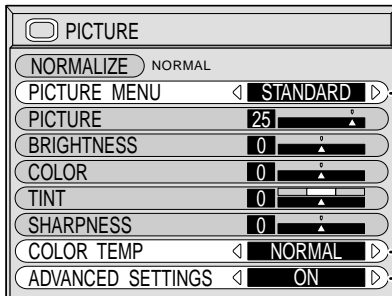
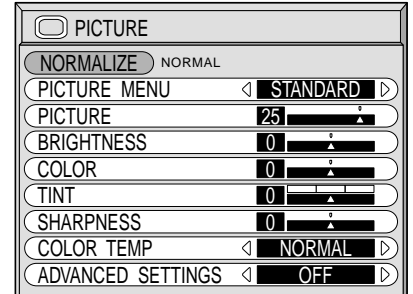

Press the left ◀ or right ▶ button to switch between modes.

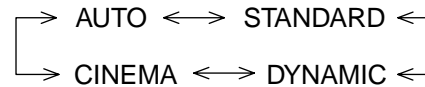

### AUTO

Automatically selects the mode that best suits the brightness of the environment.

### STANDARD

For viewing in standard (evening lighting) environments. This menu selects the normal levels of BRIGHTNESS and PICTURE.

### DYNAMIC

For viewing in brighter environments. This menu selects higher than normal levels of BRIGHTNESS and PICTURE.

### CINEMA

Ideal for movies.

### Note:

If you would like to change the picture and color of the selected PICTURE menu to something else, adjust using the items in the PICTURE menu. (see next page)

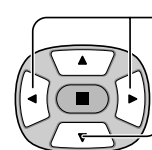
 Press to select "ON".  
Press to enter Advanced Settings.

**ADVANCED SETTINGS ON**  
Enables fine picture adjustment at a professional level (see next page).

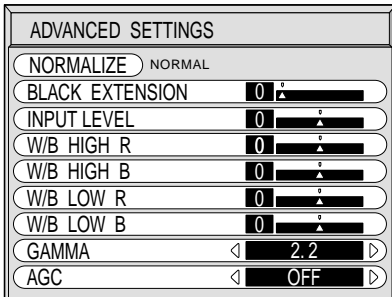

**ADVANCED SETTINGS OFF**  
Displays images with settings of the PICTURE menu.

Press the left ◀ or right ▶ button to switch between modes.

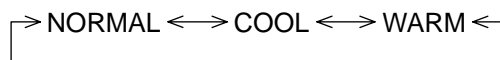

## **Helpful Hint ( / Normalization)**

While the "PICTURE" menu is displayed, if either the N button on the remote control is pressed at any time or the  (ACTION button) is pressed during "NORMALIZE", then all adjustment values are returned to the factory settings.

Item	Effect	Adjustments
PICTURE	 Less More	Adjusts the proper picture contrast.
BRIGHTNESS	 Darker Brighter	Adjusts for easier viewing of dark pictures such as night scenes and black hair.
COLOR	 Less More	Adjusts color saturation.
TINT	 Reddish Greenish	Adjust for natural flesh tones.
SHARPNESS	 Less More	Adjusts picture sharpness.

**Notes:**

- (1) "COLOR" and "TINT" settings cannot be adjusted for "RGB/PC" and "DVI" input signal.
- (2) You can change the level of each function (PICTURE, BRIGHTNESS, COLOR, TINT, SHARPNESS) for each PICTURE menu.
- (3) The setting details for STANDARD, DYNAMIC and CINEMA respectively are memorized separately for each input mode (INPUT1, INPUT2, INPUT3 and PC IN).
- (4) The "TINT" setting can be adjusted for NTSC signal only during "VIDEO (S VIDEO)" input signal.

**Note:**

In PICTURE, there is nor a noticeable change even when contrast is increased with a bright picture or reduced with a dark picture.

## ADVANCED SETTINGS

Item	Effect	Details
BLACK EXTENSION	 Less More	Adjusts the dark shades of the image in gradation. (This cannot be adjusted when the input signal is RGB or DVI.)
INPUT LEVEL	 Less More	Adjustment of parts which are extremely bright and hard to see.
W/B HIGH R	 Less More	Adjusts the white balance for light red areas.
W/B HIGH B	 Less More	Adjusts the white balance for light blue areas.
W/B LOW R	 Less More	Adjusts the white balance for dark red areas.
W/B LOW B	 Less More	Adjusts the white balance for dark blue areas.
GAMMA	 Down Up	S CURVE $\longleftrightarrow$ 2.0 $\longleftrightarrow$ 2.2 $\longleftrightarrow$ 2.5
AGC	 OFF ON	Increases the brightness of dark signal automatically.

**Notes:**

- (1) Carry out "W/B" adjustment as follows.
  - A** Adjust the white balance of the bright sections using the "W/B HIGH R" and "W/B HIGH B" settings.
  - B** Adjust the white balance of the dark sections using the "W/B LOW R" and "W/B LOW B" settings.
  - C** Repeat steps **A** and **B** to adjust.

Steps **A** and **B** affect each other's settings, so repeat each step in turn to make the adjustment.
- (2) The adjustment values are memorized separately for each input mode (INPUT1, INPUT2, INPUT3 and PC IN).
- (3) The adjustment range values should be used as an adjustment reference.



### Helpful Hint ( / Normalization)

On the remote control unit, while the "ADVANCED SETTINGS" menu is displayed, if either the N button is pressed at any time or the (ACTION button) is pressed during "NORMALIZE", then all adjustment values are returned to the factory settings.

# PRESENT TIME SETUP/SET UP TIMER

The timer can switch the Plasma Display ON or OFF.

Before attempting Timer Set, confirm the PRESENT TIME OF DAY and adjust if necessary. Then set POWER ON TIME/POWER OFF TIME.

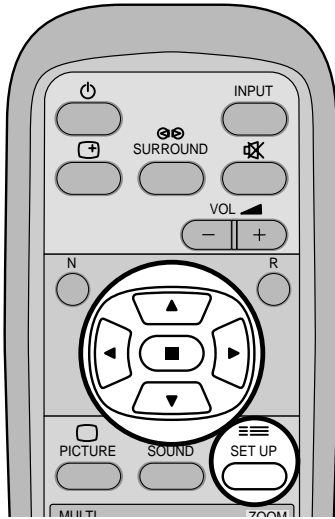

1



Press to display the SETUP menu screen.

2

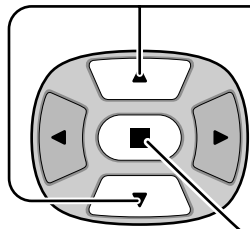

Press to select SET UP TIMER or PRESENT TIME SETUP.

Press to display the SET UP TIMER screen or PRESENT TIME SETUP screen.

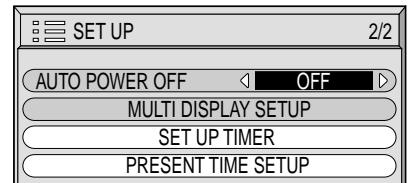
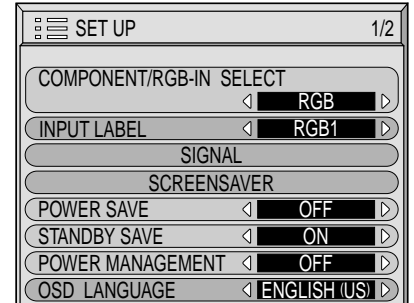

## PRESENT TIME SETUP

Display the PRESENT TIME SETUP screen.

To set up PRESENT TIME, follow the procedure described below.

1

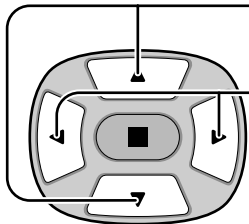

Press to select PRESENT TIME OF DAY.

Press to set up PRESENT TIME OF DAY.  
▶ button: Forward  
◀ button: Back

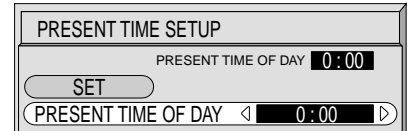

### Notes:

- Pressing "◀" or "▶" button once changes PRESENT TIME OF DAY 1minute.
- Pressing "◀" or "▶" button continuously changes PRESENT TIME OF DAY by 15 minutes.

2

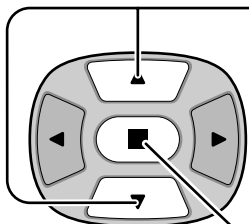

Press to select Set.

Press to store PRESENT TIME SETUP.

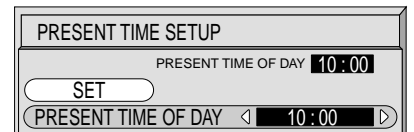

### Note:

Set cannot be selected unless PRESENT TIME OF DAY is set.



Press to exit from PRESENT TIME SETUP.



## SET UP TIMER

Display the SET UP TIMER SCREEN.

**1**

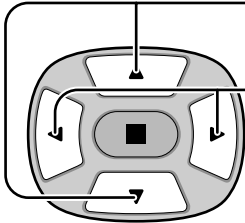

Press to select  
POWER ON TIME/POWER OFF TIME.

Press to set up POWER ON TIME/  
POWER OFF TIME.

▶ button: Forward  
◀ button: Back

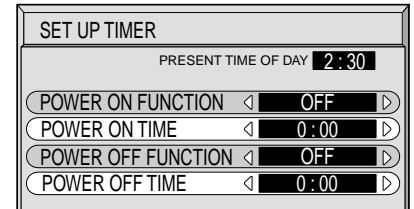

**Notes:**

- Pressing “◀” or “▶” button once changes POWER ON TIME / POWER OFF TIME 1minute.
- Pressing “◀” or “▶” button continuously changes POWER ON TIME / POWER OFF TIME by 15 minutes.

**2**

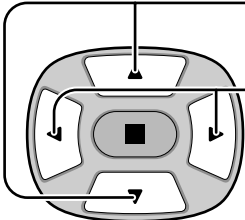

Press to select POWER ON FUNCTION/  
POWER OFF FUNCTION.

Press to select ON.

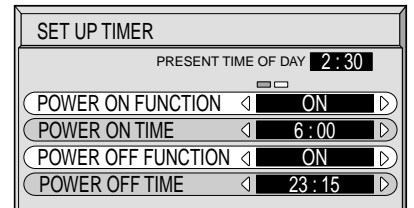

**3**



Press twice to exit from SETUP.

**Note:**

Timer function will not work unless “PRESENT TIME OF DAY” is set.

# SCREENSAVER (For preventing after-images)

Do not display a still picture, especially in 4:3 mode, for any length of time.  
If the display must remain on, a SCREENSAVER should be used.

1



Press to display the SETUP menu screen.

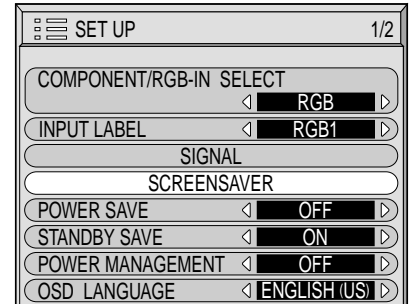

2

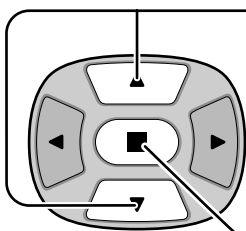

Press to select the SCREENSAVER.

Press to select the SCREENSAVER screen.

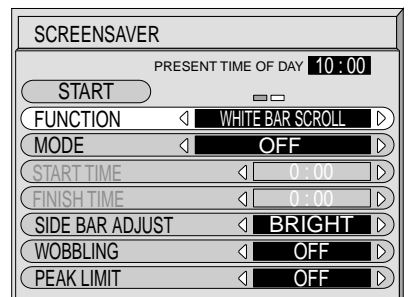

## NEGATIVE / SCROLL selection

3

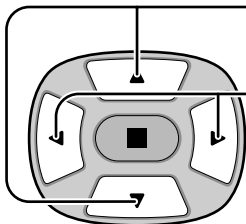

Press to select the FUNCTION.

Press to select the desired function.

WHITE BAR SCROLL ← → NEGATIVE

WHITE BAR SCROLL : A white bar will scroll from left to right.

NEGATIVE : A negative image will be displayed on the screen.

## MODE selection

4

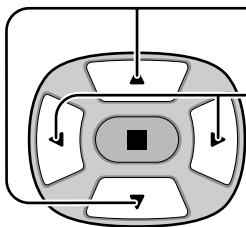

Press to select the MODE.

Press to select each mode items.

- OFF
- ↕
- INTERVAL : Operates when SHOW DURATION and SAVER DURATION are set up and those times arrive.
- ↕
- TIME OF DAY : Operates when START TIME and FINISH TIME are set up and those times arrive.
- ↕
- ON : Operates when START is selected and the (ACTION) is pressed.

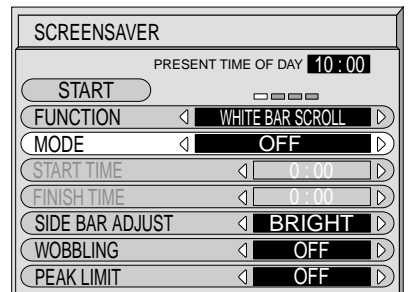

## START setting

5

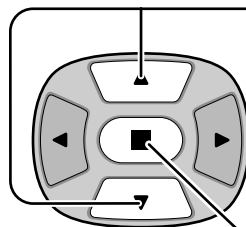

When the Mode is set to ON, press to select START.

Press to start SCREENSAVER.

The menu screen will disappear and the SCREENSAVER will be activated. To stop the SCREENSAVER under ON, press the button.

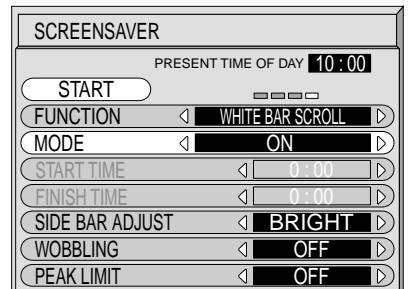

## Setup of SCREENSAVER Time

After selecting TIME OF DAY or INTERVAL, the relevant SET UP TIME will become available for selection and the OPERATING TIME may be set. (Time cannot be set when "MODE" is "ON" or "OFF.")

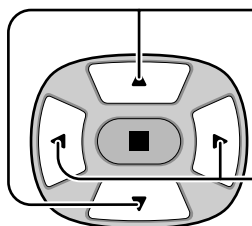
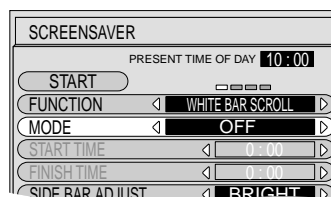
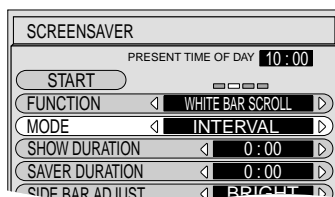
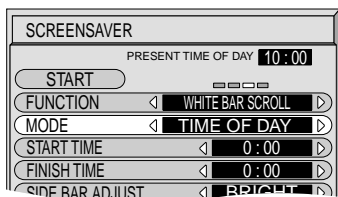

Press to select START TIME/ FINISH TIME  
(When TIME OF DAY is selected).  
Press to select SHOW DURATION/ SAVER  
DURATION (When INTERVAL is selected).

Press to set up.

- ▶ button: Forward
- ◀ button: Back

### Notes:

- Pressing "◀" or "▶" button once changes the TIME 1minute.  
[However, switching occurs every 15 minutes when Periodic Time is selected.]
- Pressing "◀" or "▶" button continuously changes the TIME by 15 minutes.

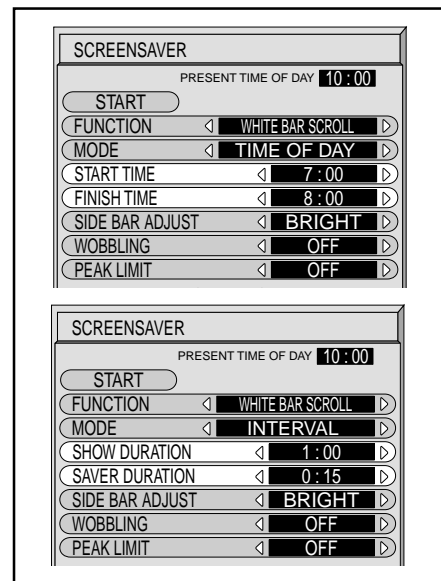
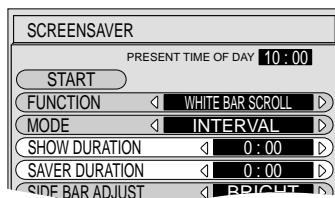
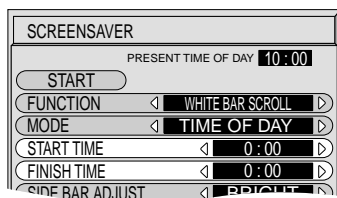

**Note:** Timer function will not work unless "PRESENT TIME OF DAY" is set.

## Reduces screen after-image

These functions prevent the occurrence of an "after image" on the display when turned ON.

**WOBBLING** : Automatically shifts the display image at a dot level pitch (therefore unnoticeable to the eye) over time to prevent after image of sharper contour of image.

**PEAK LIMIT** : Suppresses image contrast (peak brightness).

- 1 Press to display the SET UP menu screen.
- 2 Press to select "SCREENSAVER".
- 3 Press to display SCREENSAVER menu.
- 3 Press to select "WOBBLING" or "PEAK LIMIT".
- 3 Press to select "ON" or "OFF".

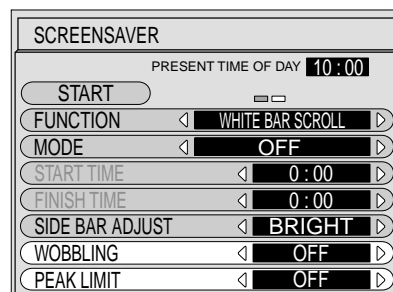
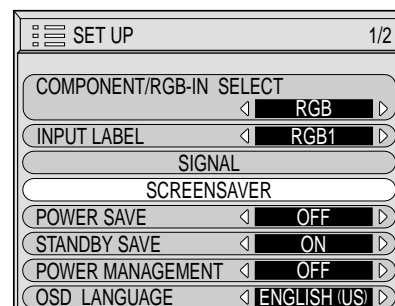

# SCREENSAVER (For preventing after-images )

## SIDE BAR ADJUST

Do not display a picture in 4:3 mode for an extended period, as this can cause an after-image to remain on the side bars on either side of the display field.

To prevent the appearance of such an after-image, change the brightness of the side bars.

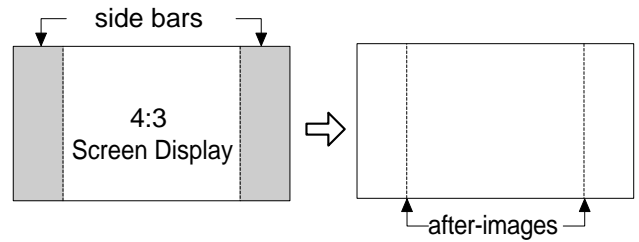

This function may be applicable to the non-picture area.

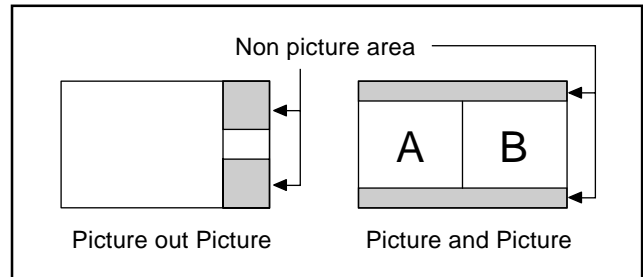

**1** To display the SCREENSAVER screen.  
(Refer to the previous page, operation guide steps 1 and 2)

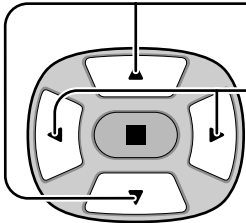
**2**  Press to select the SIDE BAR ADJUST.  
Press to select OFF, DARK, MID, BRIGHT.

**3**  Press to exit from SCREENSAVER.

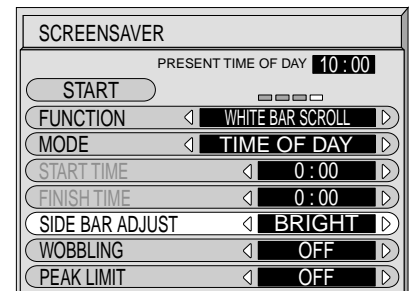

### Notes:

- Setting the side bar to bright mode for an extended period may result in occurrence of after-images.
- The side bar may flash (alternate black/white) depending on the picture being shown on the screen. In such an occurrence, use the Cinema mode.

# Digital Zoom

This displays an enlargement of the designated part of the displayed image.

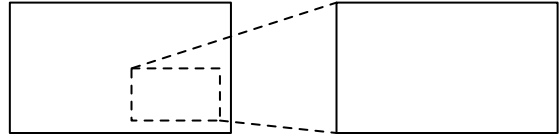

## 1 Display the "Operation Guide".

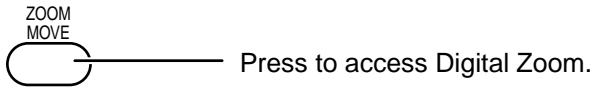

The "Operation Guide" will be displayed.

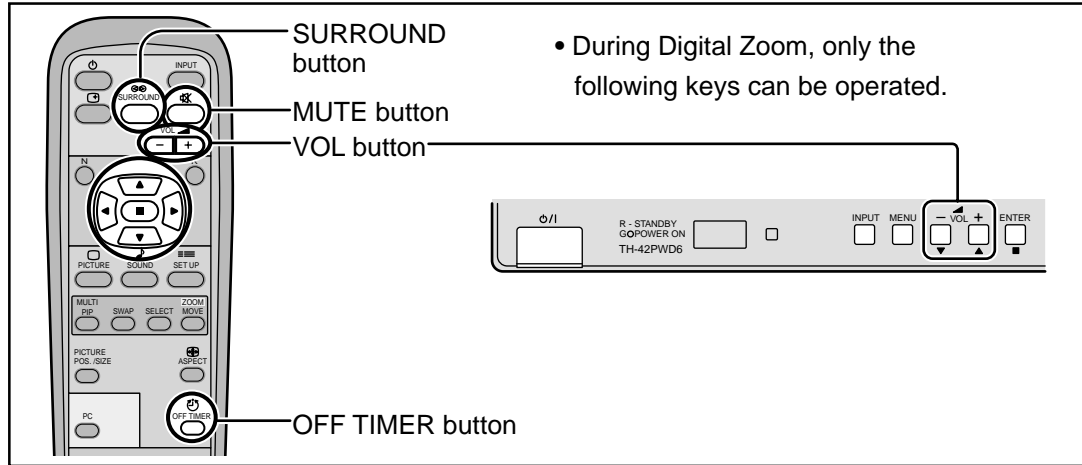
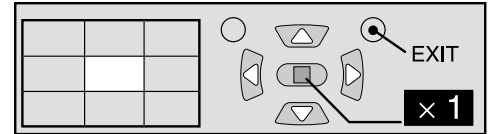

## 2 Select the area of the image to be enlarged.

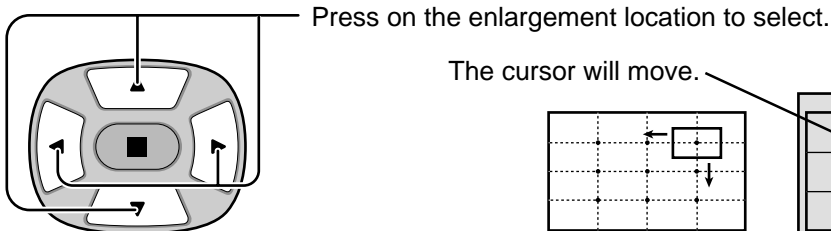

## 3 Select the magnification required for the enlarged display.

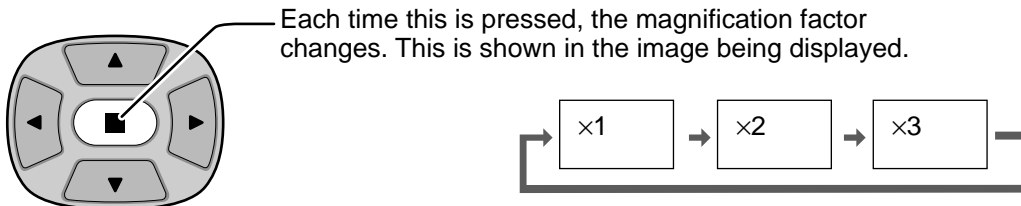

## 4 Return to normal display (quit Digital Zoom).

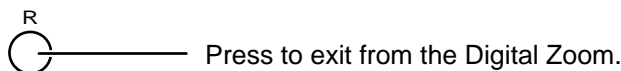

### Notes:

- (1) When power goes OFF (including "Off Timer" operation), Digital Zoom terminates.
- (2) The Digital Zoom function cannot be selected while in the following operation states:
  - "Multi-screen" (MULTI DISPLAY).(see page 31)
  - "Multi-viewer" (Picture in Picture, Picture out Picture, Picture and Picture) operation. (see page 14)
- (3) While Digital Zoom is in operation, "Adjusting Picture Pos./Size" cannot be used.
- (4) For RGB/PC input signals, normal multi-display magnification is only available at the VGA, SVGA and XGA resolution.
- (5) The Digital Zoom capability is functional for the following component signals:  
525 (480) / 60i · 60p, 625 (575) / 50i · 50p, 1125 (1080) / 60i · 50i · 24sF, 750 (720) / 60p · 50p, 1250 (1080) / 50i
- (6) The Digital Zoom capability is functional for the following composite signals:  
NTSC, PAL, SECAM

# Reduces power consumption

- **POWER SAVE:** When this function is turned ON, luminous level of the plasma display is suppressed, so power consumption is reduced.
- **STANDBY SAVE:** When this function is turned ON, power consumption of the microcomputer is reduced during power supply standby (see page 13,14,15), so standby power of the set is reduced.
- **POWER MANAGEMENT:** The unit power supply is turned ON or OFF depending on whether or not there is a signal during PC input mode. This function is enabled when it is turned ON. (Only during input from PC(Mini D-sub) terminal)
- **AUTO POWER OFF:** Equipment power supply is turned OFF when there is no signal. When this is set to On, the power supply of the unit goes Off 10 minutes after the input signals stop. This function is effective for input signals except input from PC (Mini D-sub) terminal.

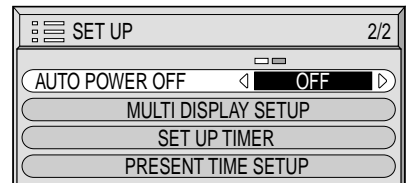
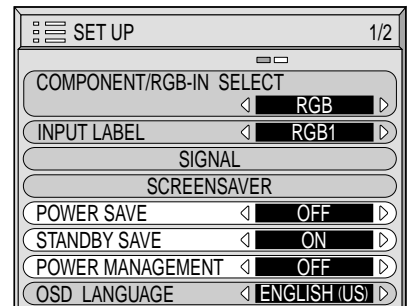
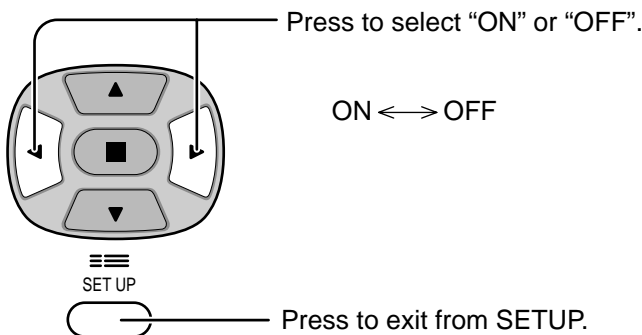
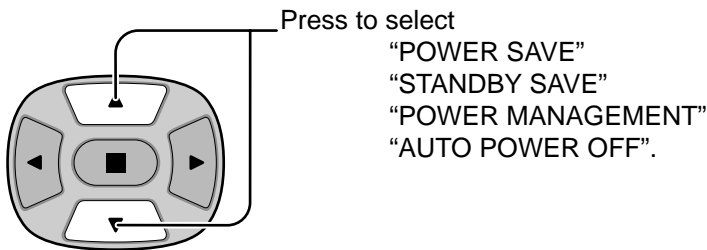

**Note:**

"POWER MANAGEMENT" and "AUTO POWER OFF" are effective during normal viewing (one picture screen) only.

## Customizing the Input labels

This function can change the label of the Input signal to be displayed.

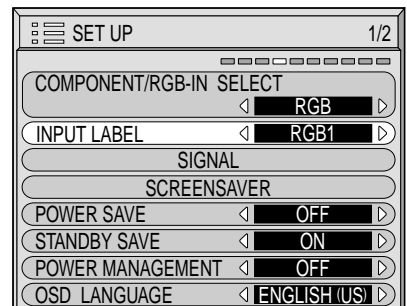
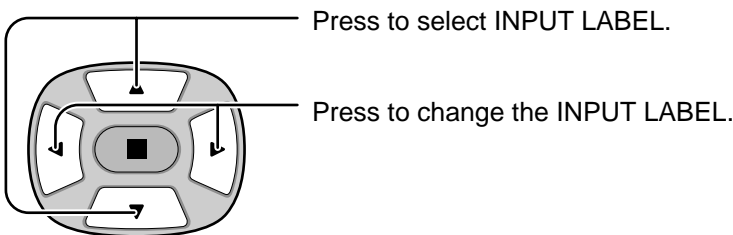

**Notes:**

While selecting a Input signal through Optional Terminal Board connected to Slot 1 to Slot 3, the Input label will depend on each Optional Terminal Board.

INPUT LABELS for Slot 1 to Slot 3 and miniD-sub:

- [Slot1 Input] INPUT1/VIDEO1/COMPONENT1/RGB1/RGB1(digital)/PC1/DVD1/CATV1/VCR1/STB1
- [Slot2 Input] INPUT2/VIDEO2/COMPONENT2/RGB2/RGB2(digital)/PC2/DVD2/CATV2/VCR2/STB2
- [Slot3 Input] INPUT3/VIDEO3/COMPONENT3/RGB3/PC3/DVD3/CATV3/VCR3/STB3
- [PC (MiniD-sub) input] PC/COMPONENT/RGB/DVD/STB

# Setup for MULTI DISPLAY

- ① By lining up Plasma Displays in groups of 4 or 9 as illustrated below, an enlarged picture may be displayed across all screens.
- ② For this mode of operation, each plasma display has to be set up with a DISPLAY number to determine its location.

group of 4 (2x2)



group of 9 (3x3)



## How to setup MULTI DISPLAY

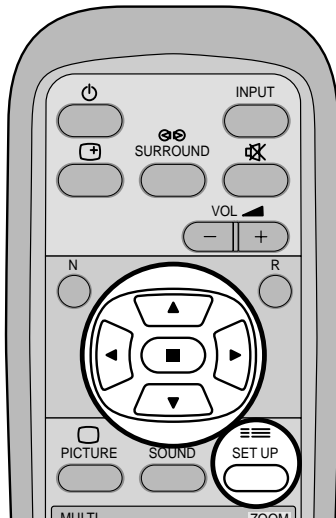

1



Press to display the SETUP menu screen.

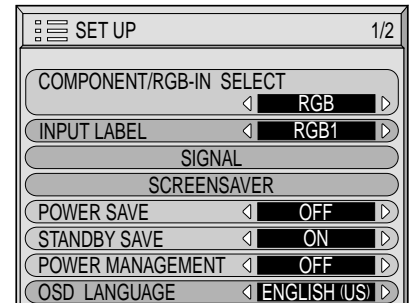

2

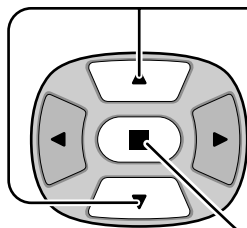

Press to select the MULTI DISPLAY SETUP.

Press to display the "MULTI DISPLAY SETUP" menu.

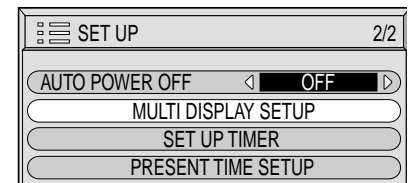

3

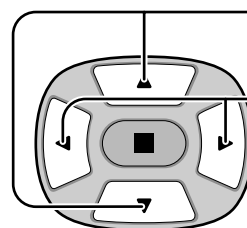

Press to select the MULTI DISPLAY SETUP.

Press to select "ON" or "OFF".

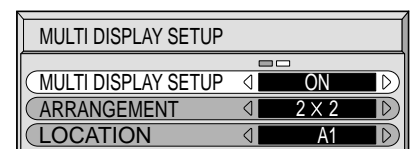

## How to set the Display location number for each Plasma Display

**4**

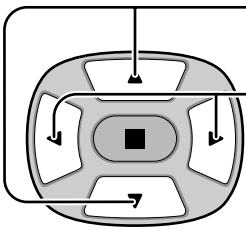

Press to select ARRANGEMENT (2nd step).

Press to select "2x2", "3x3".

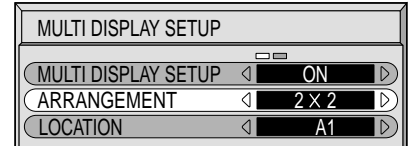

**5**

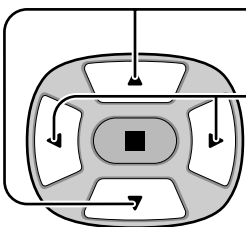

Press to select LOCATION.

Press to select the required arrangement number. (A1-C3 : Refer to the following)

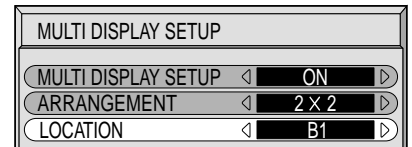

DISPLAY NUMBER locations for each arrangement.

(2x2)

A1	A2
B1	B2

(3x3)

A1	A2	A3
B1	B2	B3
C1	C2	C3

**6**



Press twice to exit from SETUP.

**Notes:**

- (1) For RGB/PC input signals, normal multi-display magnification is only available at the VGA, SVGA and XGA resolution.
- (2) The multi-display capability is functional for the following component signals:  
525 (480) / 60i · 60p, 625 (575) / 50i · 50p, 1125 (1080) / 60i · 50i · 24sF, 750 (720) / 60p · 50p, 1250 (1080) / 50i
- (3) The multi-display capability is functional for the following composite signals:  
NTSC, PAL, SECAM
- (4) The MultiDisplay (multiskærmdisplay) function does not display certain input signals from the terminals of the installed option boards listed below:
  - Digital RGB input signals from the DVI terminal of RGB (Digital) Terminal Board (TY-42TM6D)



# SET UP for Input Signals

## COMPONENT/RGB IN SELECT

Select to match the signals from the source connected to the COMPONENT/RGB input terminals.

Y, P<sub>B</sub>, P<sub>R</sub> signals ⇔ "COMPONENT"

R, G, B, HD, VD signals ⇔ "RGB"

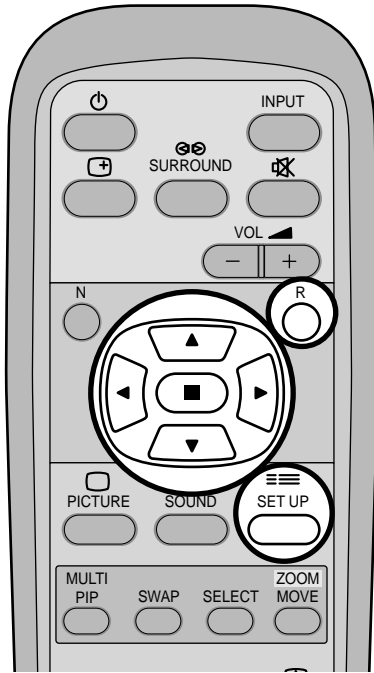

**1**  Press to display the SET UP menu screen.

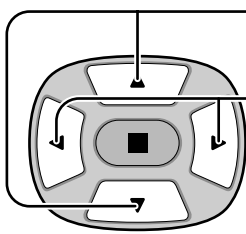
**2**  Press to select the "COMPONENT/RGB IN SELECT".

Press to select the desired mode.

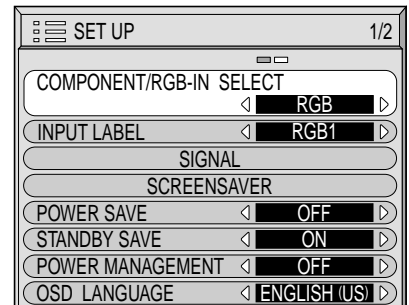

COMPONENT ← → RGB

 Press to exit from adjust mode.

### Note:

Selection may not be possible, depending on which optional board is installed.

## 3D Y/C FILTER – For NTSC Video images

Select "SIGNAL" from the "SET UP" menu during VIDEO (S VIDEO) input signal mode.

("SIGNAL [VIDEO]" menu is displayed.)

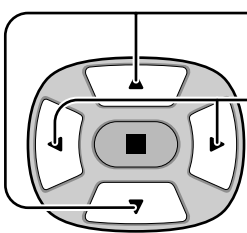
 Press to select the "3D Y/C FILTER (NTSC)".

Press to set ON/OFF.

 Press to exit from adjust mode.

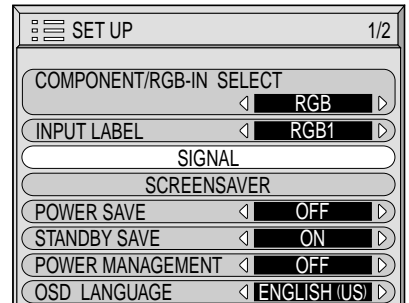

Press  (ACTION) button

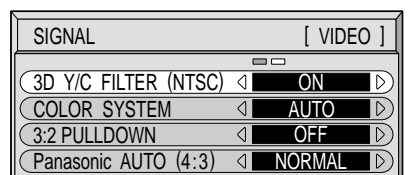

### Note:

When ON, this setting only affects NTSC input signals.

## COLOR SYSTEM / Panasonic AUTO

Select SIGNAL from the “SET UP” menu during VIDEO (S VIDEO) input signal mode. (“SIGNAL [VIDEO]” menu is displayed.)

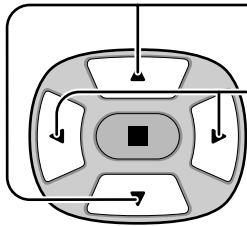

Press to select the “COLOR SYSTEM” or “Panasonic AUTO”.

Press to select each function.

### If the image becomes unstable:

With the system set on Auto, under conditions of low level or noisy input signals the image may in rare cases become unstable. Should this occur, set the system to match the format of the input signal.

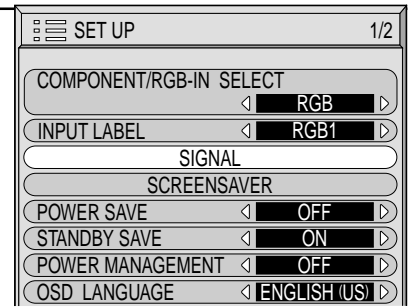

Press (ACTION) button

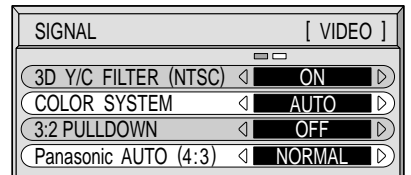

Mode	Function
COLOR SYSTEM	Set the color system to match the input signal. If set to “AUTO”, the color system is determined automatically. <div style="text-align: center;"> </div>
Panasonic AUTO (4:3)	Set to “NORMAL” to view 4:3 images in an unchanged format when Panasonic AUTO is selected. If you would like to view 4:3 images in Just format, set to “JUST”.

## 3:2 PULLDOWN

When ON, the display attempts to reproduce a more natural interpretation of sources such as movie pictures, which are recorded at 24 frames per second.

If the picture is not stable, turn the setting to OFF.

Select “SIGNAL” from the “SET UP” menu during VIDEO (S VIDEO) or COMPONENT input signal. (“SIGNAL [VIDEO]” or “SIGNAL [COMPONENT]” menu is displayed.)

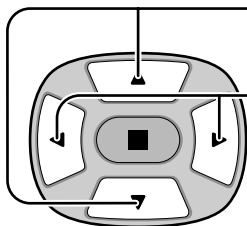

Press to select 3:2 PULLDOWN.

Press to set ON/OFF.



Press to exit from adjust mode.

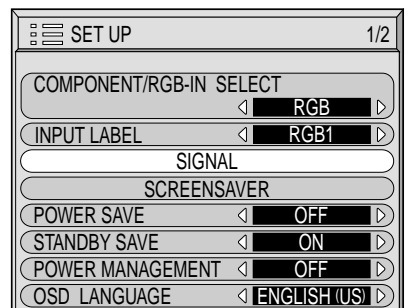

Press (ACTION) button

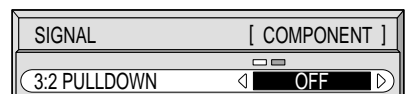
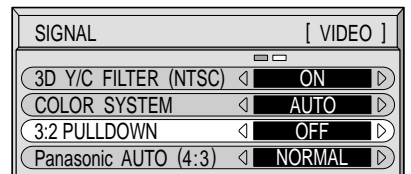

### Note:

When ON, this setting only affects the following signal input:

- NTSC / PAL signal input during “VIDEO (S VIDEO)” input signal.
- 525i(480i) signal input during “COMPONENT” input signal.

## SYNC

Select SIGNAL from the "SET UP" menu during RGB input signal.

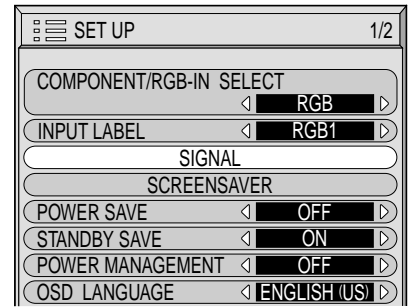
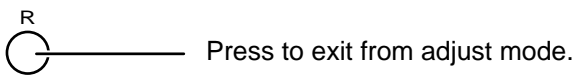
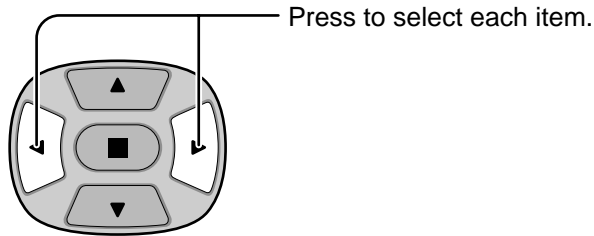

↓ Press (ACTION) button

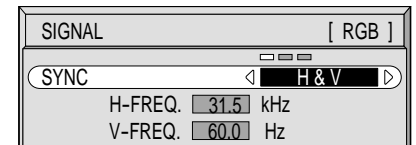

### Note:

Sync cannot be adjusted while a DVI signal is being applied.

### Setting RGB sync signal

Confirm that the input is set to RGB INPUT (this setting is valid only for RGB INPUT signal).

- H & V: The H and V sync signals are input from the HD/VD connector.
- ON G: Uses a synchronized signal on the Video G signal, which is input from the G connector.
- CS: Uses a synchronized signal of Composite Sync input.

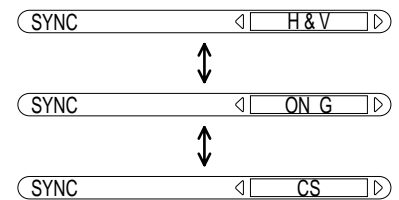

## H-FREQ. (kHz)/V-FREQ. (Hz)

Displays the H (Horizontal)/V (Vertical) frequencies.

This display is valid only for RGB/PC and DVI input signal.





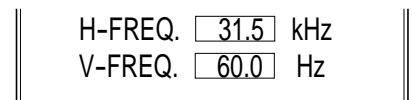

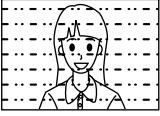
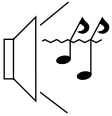

Display range:

- Horizontal 15 - 110 kHz
- Vertical 48 - 120 Hz

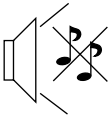

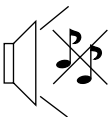
# Troubleshooting

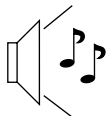
Before you call for service, determine the symptoms and make a few simple checks as shown below.

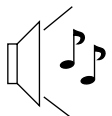
Symptoms		Checks
Picture	Sound	
 Interference	 Noisy Sound	Electrical Appliances Cars/Motorcycles Fluorescent light
 Normal Picture	 No Sound	Volume (Check whether the mute function has been activated on the remote control.)
 No Picture	 No Sound	Not plugged into AC outlet Not switched on PICTURE and BRIGHTNESS/Volume setting (Check by pressing the power switch or stand-by button on the remote control.)
 No Picture	 Normal Sound	If a signal with a non-applicable color system format, or frequency is input, only the input terminal indication is displayed.
 No Color	 Normal Sound	Color controls set at minimum level. (see page 22, 23) COLOR SYSTEM (see page 34)

This Plasma Display uses special image processing. Hence a slight time lag may occur between image and audio, depending on the type of input signal. However, this is not a malfunction.

## Plasma Display panel

Symptoms	Check
Some parts of the screen do not light up.	The plasma display panel is manufactured using an extremely high level of precision technology, however, sometimes some parts of the screen may be missing picture elements or have luminous spots. This is not a malfunction.
 After-images appear	Do not allow a still picture to be displayed for an extended period, as this can cause a permanent after-image to remain on the Plasma Display. Examples of still pictures include logos, video games, computer images, teletext and images displayed in 4:3 mode. <b>Note:</b> The permanent after-image on the Plasma Display resulting from fixed image use is not an operating defect and as such is not covered by the Warranty. This product is not designed to display fixed images for extended periods of time.
[for TH-42PHD6, TH-50PHD6] Whirring sounds can be heard from the display unit.	The display unit is fitted with a cooling fan to dissipate heat generated during normal use. The whirring sound is caused by rotation of the fan and is not a malfunction.

# VIDEO/COMPONENT/RGB/PC input signals

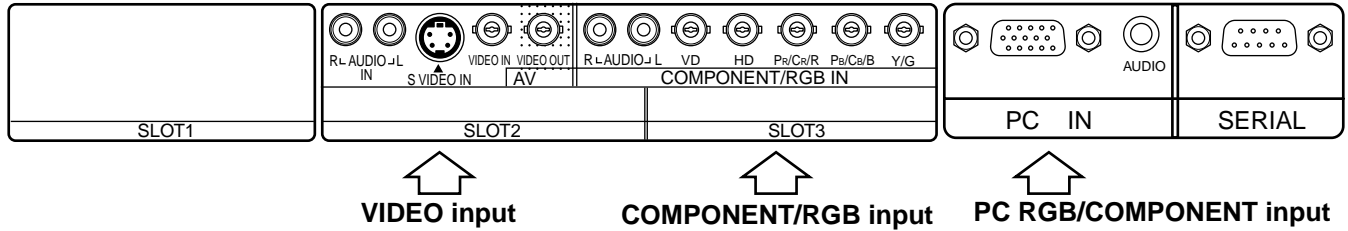

## VIDEO input [Applicable when Multi Screen and Digital Zoom]

	Signal name	Horizontal frequency(kHz)	Vertical frequency(Hz)
1	NTSC	15.73	59.94
2	PAL	15.63	50.00
3	PAL60	15.73	59.94
4	SECAM	15.63	50.00
5	Modified NTSC	15.73	59.94

## Applicable input signals for PC Input (D-sub 15P) (\* Mark)

	Signal name	Horizontal frequency(kHz)	Vertical frequency(Hz)	COMPONENT	RGB	PC	When Multi Screen and Digital Zoom
1	525 (480) /60i	15.73	59.94	*	*	*	*
2	525 (480) /60p	31.47	59.94	*	*	*	*
3	625 (575) /50i	15.63	50.00	*	*	*	*
4	625 (575) /50p	31.25	50.00	*	*	*	*
5	750 (720) /60p	45.00	60.00	*	*	*	*
6	750 (720) /50p	37.50	50.00	*	*	*	*
7	1,125 (1,080) /60i	33.75	59.94	*	*	*	*
8	1,125 (1,080) /50i	28.13	50.00	*	*	*	*
9	1,125 (1,080) /24p	27.00	24.00	*	*	*	
10	1,125 (1,080) /24sF	27.00	48.00	*	*	*	*
11	1,250 (1,080) /50i	31.25	50.00	*	*	*	*
12	640 × 400 @70	31.47	70.00		*	*	*
13	640 × 480 @60	31.47	59.94		*	*	*
14	Macintosh13" (640 × 480)	35.00	66.67		*	*	*
15	640 × 480 @75	37.50	75.00		*	*	*
16	852 × 480 @60	31.50	60.00		*	*	*
17	800 × 600 @60	37.88	60.32		*	*	*
18	800 × 600 @75	46.88	75.00		*	*	*
19	800 × 600 @85	53.67	85.06		*	*	*
20	Macintosh16" (832 × 624)	49.73	74.55		*	*	*
21	1,024 × 768 @60	48.36	60.00		*	*	*
22	1,024 × 768 @70	56.48	70.07		*	*	*
23	1,024 × 768 @75	60.02	75.03		*	*	*
24	1,024 × 768 @85	68.68	85.00		*	*	*
25	Macintosh21" (1,152 × 870)	68.68	75.06		*	*	
26	1,280 × 1,024 @60	63.98	60.02		*	*	
27	1,280 × 1,024 @75	79.98	75.03		*	*	
28	1,280 × 1,024 @85	91.15	85.02		*	*	
29	1,600 × 1,200 @60	75.00	60.00		*	*	
30	1,067 × 600 @60	37.88	60.32		*	*	*
31	1,366 × 768 @60	48.36	60.00		*	*	*

**Note:** Signals without above specification may not be displayed properly.

# Specifications

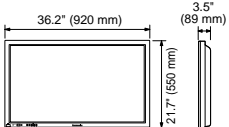
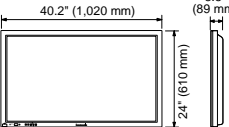
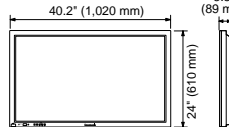
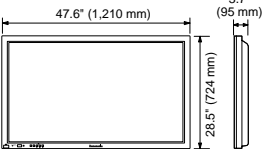
	TH-37PWD6	TH-42PWD6	TH-42PHD6	TH-50PHD6
<b>Power Source</b>	120 V AC, 50/60 Hz			
<b>Power Consumption</b>				
Maximum	325 W	395 W	max. Amps. 5 A	max. Amps. 5.5 A
Stand-by condition	Save OFF 1.5W, Save ON 0.6W	Save OFF 1.5W, Save ON 0.6W	Save OFF 1.6W, Save ON 0.9W	Save OFF 1.6W, Save ON 0.9W
Power off condition	0.4 W	0.4 W	0.2 W	0.2 W
<b>Plasma Display panel</b>	Drive method : AC type 37-inch, 16:9 aspect ratio	Drive method : AC type 42-inch, 16:9 aspect ratio		Drive method : AC type 50-inch, 16:9 aspect ratio
Contrast Ratio	4000 : 1		3000 : 1	
<b>Screen size</b>	818 mm (W) × 461 mm (H), 939 mm (diagonal)	920 mm (W) × 518 mm (H), 1,056 mm (diagonal)		1,106 mm (W) × 622 mm (H), 1,269 mm (diagonal)
(No. of pixels)	408,960 (852 (W) × 480 (H)) [2,556 × 480 dots]		786,432 (1,024 (W) × 768 (H)) [3,072 × 768 dots]	1,049,088 (1,366 (W) × 768 (H)) [4,098 × 768 dots]
<b>Operating condition</b>	Temperature	32 °F - 104 °F (0 °C - 40 °C)		
	Humidity	20 % - 80 %		
<b>Applicable signals</b>				
Color System	NTSC, PAL, PAL60, SECAM, Modified NTSC			
Scanning format	525 (480) / 60i · 60p, 625 (575) / 50i · 50p, 750 (720) / 60p · 50p, 1125 (1080) / 60i · 50i · 24p · 24sF .... SMPTE274M, 1250 (1080) / 50i			
PC signals	VGA display VGA SVGA, XGA, SXGA, UXGA ..... (compressed)		XGA display VGA, SVGA, XGA SXGA, UXGA ..... (compressed)	
	Horizontal scanning frequency 15 - 110 kHz Vertical scanning frequency 48 - 120 Hz			
<b>Connection terminals</b>				
AV	VIDEO IN/OUT (BNC) S VIDEO IN (MINI DIN 4PIN) AUDIO IN (RCA PIN JACK × 2)		1.0 Vp-p (75-ohm or high impedance) Y: 1 Vp-p (75-ohm), C: 0.286 Vp-p (75-ohm) 0.5 Vrms (high impedance)	
COMPONENT/RGB	Y/G (BNC)  PB/B (BNC), PR/R (BNC) HD (BNC), VD (BNC) AUDIO IN (RCA PIN JACK × 2)		1.0 Vp-p/composite (75-ohm) 0.7 Vp-p/non-composite (75-ohm) 0.7 Vp-p (75-ohm) 1.0 - 5.0 Vp-p (high impedance) 0.5 Vrms (high impedance)	
PC	(HIGH-DENSITY D-SUB 15PIN) Component Y : Pb/Cb : Pr/CR :  AUDIO IN (M3 JACK)	R,G,B/0.7 Vp-p (75-ohm) 1.0 Vp-p (75-ohm : include sync) ± 0.35 Vp-p (75-ohm) ± 0.35 Vp-p (75-ohm) HD, VD/1.0 - 5.0 Vp-p (high impedance) 0.5 Vrms (high impedance)		
SERIAL	EXTERNAL CONTROL TERMINAL (D-SUB 9PIN) RS-232C COMPATIBLE			
SPEAKERS (6 Ω)	16W [8 W + 8 W] (10 % THD)			
<b>Accessories Supplied</b>				
Remote Control Transmitter	EUR646529			
Batteries	2 × AA Size			
Fixing bands	(TMME203 or TMME 187) × 2			
Ferrite core	J0KF00000018 × 1, J0KF00000054 × 2			
<b>Dimensions (W × H × D)</b>	36.2" (920 mm) × 21.7" (550 mm) × 3.5" (89 mm)	40.2" (1,020 mm) × 24" (610 mm) × 3.5" (89 mm)	40.2" (1,020 mm) × 24" (610 mm) × 3.5" (89 mm)	47.6" (1,210 mm) × 28.5" (724 mm) × 3.7" (95 mm)
				
<b>Mass (Weight)</b>	approx. 53.9 lbs (main unit only) approx. 63.3 lbs (with speakers)	approx. 64.6 lbs (main unit only) approx. 73.9 lbs (with speakers)	approx. 66.1 lbs (main unit only) approx. 75.4 lbs (with speakers)	approx. 97.0 lbs (main unit only) approx. 107.1 lbs (with speakers)

**Note:**

Design and specifications are subject to change without notice. Mass and dimensions shown are approximate.



**Customer's Record**

The model number and serial number of this product can be found on its back cover. You should note this serial number in the space provided below and retain this book, plus your purchase receipt, as a permanent record of your purchase to aid in identification in the event of theft or loss, and for Warranty Service purposes.

Model Number \_\_\_\_\_

Serial Number \_\_\_\_\_

---

**Panasonic Broadcast & Television Systems Company**

Unit of Matsushita Electric Corporation of America

**Executive Office :**

One Panasonic Way 4E-7, Secaucus, NJ 07094 (201) 348-7000

**EASTERN ZONE :** One Panasonic Way 4E-7 Secaucus, NJ 07094 (201) 348-7621

Mid-Atlantic/New England : One Panasonic Way 4E-7 Secaucus, NJ 07094 (201) 348-7621

Southeast Region : 1225 Northbrook Parkway, Ste 1-160 Swanee GA 30024 (770)338-6835

Central Region : 1707 N Randall Road E1-C-1, Elgin, IL 60123 (847)468-5200

**WESTERN ZONE :** 3330 Cahuenga Blvd W., Los Angeles, CA 90068 (323) 436-3500

Dallas Region : 6226 Abington Way, Houston, TX 77008 (713) 802-2726

No. CA/Northwest Region : 5870 Stone Ridge, #3, Pleasanton, CA (925) 416-5108

**Government Marketing Department :** 52 West Gude Drive, Rockville, MD 20850 (301) 738-3840